



© Peak Production, Matteo Garrone

2026 Handbook

Constitution and Class Rules



ILCA HALL OF FAME

The ILCA Hall of Fame includes those who have helped build our class and champion sailors who have made an extraordinary impact. The ILCA World Council established the selection criteria for entry as individuals who, over the course of their sailing careers, made an outstanding impact on ILCA and the sport of sailboat racing by virtue of the excellence of their achievements as sailors and/or contributors to competitive sailing through technical expertise, design, writing or vision. Inductees receive a unique Hall of Fame ILCA Cube. Nominations to the Hall of Fame are welcomed from any ILCA Class member, with a selection vote to be made by the ILCA World Council.



Ian Bruce
(Canada)



Bruce Kirby
(Canada)



Jeff Martin
(Great Britain)



Marit Söderström Nord
(Sweden)



Takao Otani
(Japan)



Robert Scheidt
(Brazil)



Peter Seidenberg
(USA)



Dick Tillman
(USA)



Tracy Usher
(USA)

BUSINESS OFFICE

ILCA, PO Box 49250, Austin, Texas, 78765, USA

Tel: +1-512-270-6727 Email: office@ilcasailing.org Website: www.ilcasailing.org

www.facebook.com/intlaserclass https://www.instagram.com/ilca_sailing

REGIONAL OFFICES

AFRICA

Chairperson: Nuno Gomes
Tel: +244 924 987 900
Email: ngomes999@gmail.com
Web: www.africa.ilcasailing.org

EUROPE

Chairperson: Jean-Luc Michon
Societe Nautique de Genève, Port Noir,
CH-1223 Cologny, Suisse
Email: entreyeurilca@gmail.com
Web: www.eurilca.org / www.eurilca.eu

NORTH AMERICA

Chairperson: Ryan Minth
Executive Secretary: Scott Williamson
Tel: +1 443-767-3494
Email: office@ilcanasailing.org
Web: <https://ilcanasailing.org>

ASIA

Chairperson: Aileen Loo
Tel: +65 8306 1303
Email: chair.ILCA.Asia@gmail.com
Web: www.ilcaasia.org

CENTRAL AND SOUTH AMERICA

Chairperson: Carlos Palombo
San Lorenzo 315 Piso 13, La Lucila,
(c.p.1636) Buenos Aires, Argentina
Tel: +54 11 4799 1285
Mob: +54 911 4445 4253
Email: charlypalombo@gmail.com
Web: www.ilcasudamerica.org/

OCEANIA

Chairperson: Ken Hurling
PO Box 5242 Greenwich,
NSW 2065, Australia
Tel: +61 404 17644086
Email: kenhurling47@gmail.com
Web: oceania.ilcasailing.org

WORLD COUNCIL MEMBERS

President Mark Lyttle (GBR) president@ilcasailing.org
Vice President/Chief Measurer/Asia Chairperson Aileen Loo (SGP) ladyhelm@hotmail.com
Executive Secretary..... Eric Faust (USA) office@ilcasailing.org
Treasurer Nick Page (NZL) pages4@xtra.co.nz
Africa Chairperson..... Nuno Gomes (ANG) ngomes999@gmail.com
Central & South America Chairperson..... Carlos Palombo (ARG) charlypalombo@gmail.com
Europe Chairperson Jean-Luc Michon (FRA) michonjl@hotmail.com
Second Europe Representative..... Virginia Kravarioti (GRE) kravarioti_v@hotmail.com
North America Chairperson Ryan Minth (USA) ryan@cvane.com
Oceania Chairperson..... Ken Hurling (AUS) kenhurling47@gmail.com
Chief Technical Officer..... Santiago Sampaio (POR) technical@ilcasailing.org
Builder Representative Chris Turner (GBR) chris.turner@ovingtonboats.co.uk
Appointed Non-Voting Member Hugh Leicester (AUS) hugh@hydrotechnics.com.au

TECHNICAL AND MEASUREMENT COMMITTEE

Mark Lyttle (GBR), Chris Turner (GBR), Aileen Loo (SGP), Santiago Sampaio (POR)

CHIEF MEASURER

Aileen Loo (SGP).....chiefmeasurer@ilcasailing.org

TECHNICAL OFFICERS

Santiago Sampaio (POR) / Chris Tunstall (GBR) / Louis Moysan (FRA) / Margarida Lopes (POR) / Ravi Subramanian (USA) / Andrew Holdsworth (GBR) **Technical Consultant:** Clive Humphris (AUS)

HONORARY OFFICERS

Honorary President..... Peter Griffiths (NZL) Honorary Chief Measurer Paul Millsom (AUS)
Honorary Vice President. Hermann Cornelius (GER) Honorary Secretary Jeff Martin (GBR)

www.ilcasailing.org

ILCA 2026 Handbook

© ILCA

No part of this publication may be reproduced without prior permission of the ILCA

CONTENTS

| | | | |
|----|--|----|--|
| 1. | Administration & World Council | 14 | Constitution |
| 2. | Contents Table | 18 | Protecting the One Design Principle |
| 3 | From our President | 20 | ILCA Class Worldwide |
| 4 | Go Sailing, Go Racing | 22 | Boat Care |
| 5 | The ILCA Class Formula | 23 | Class Rules |
| 6 | ILCA Age Policy and Useful Information | 32 | Class Rule Interpretations |
| 7 | Handicap Numbers | 32 | Instructions for Applying Red Rhombus For Women's Events |
| 8 | Coaching and Coaches | 33 | Measurement Diagrams |
| 8 | Advertising on sails | 40 | Concave Batten Caps |
| 8. | Anti-doping | 41 | Measurement Bylaw |
| 9 | What is ILCA? | 42 | Technical Tips |
| 11 | Finance | 44 | Instructions for Applying Sail Numbers |
| 12 | Website | 50 | World Championship Archives |
| 13 | Parts of the boat | | |

This Handbook is published every year by the ILCA and distributed to class members throughout the world. If there are any changes to the information contained in this Handbook, including changes to the class rules and Bylaws, we will publish them on the ILCA website www.ilcasailing.org.

If you are not an ILCA member consider joining us by contacting your national ILCA Class association through the contacts list on our website.



Eric Faust
ILCA Executive Secretary



From our President



Dear ILCA sailors,

I am delighted to update you as your new President. I would like to start by thanking Tracy Usher for his commitment and passion to ILCA sailing over many years, particularly his work as President in guiding the class through the transition from Laser to ILCA. I am delighted to say that the World Council has made the very well-deserved induction of Tracy to the ILCA Hall of Fame in recognition of his dedication and contribution to the class over these many years.

Just a little about me. I got my first Laser in 1977 (yes it had a wooden tiller), grew up sailing in Dun Laoghaire, doing events around Ireland and internationally. I sailed a Laser in 1996 Olympics for Ireland and have lived in London since then, where I have raced regularly in ILCAs at Queen Mary Sailing Club. I started doing Master events in UK in 2017 and have competed in three Masters Worlds and two Europeans since then.

I am passionate about ILCA sailing. It is truly a class for everyone, and we are in a strong position. We have two Olympic events in ILCA 7 and ILCA 6, which continue to attract the best sailors in the world to what we know is the most competitive class. The ILCA is still considered a “rite of passage” for those aspiring to the top of the sport. Our Under-21 and Youth World championships continue to have super numbers with close to 40 countries, and a recent ILCA 4 Worlds that had 427 sailors from 51 countries. The 2025 Masters Worlds in Italy had 445 sailors from 38 countries, evidence of the enduring appeal of our class across all age groups. But it is not just in big championships, the class is thriving at the local level in clubs around the world.

Why is this? One reason quoted by many of you is the strict one-design nature of our class. To race competitively in an ILCA requires skill and experience, as everyone has the same equipment. This is the essence of our class. With the transition from Laser to ILCA, we have ten builders, as well as multiple suppliers of sails, spars and foils. We are, of course, not a “measurement class,” so if you have an ILCA or Laser with a World Sailing plaque, it is class legal and the same applies to our branded, approved parts. To support this, we have a sophisticated audit system of builders and suppliers, where building variances are categorised by priority and reported. All ILCA boats, as well as sails, spars, and foils, are now recorded in a central registry, accessible with a QR code, all managed by a custom app and database. The aim of all of this is to continue the trend, started with the move from Laser to ILCA, to have significantly tighter tolerances on everything from hulls to sails (the OSEPODS strategy) – focussed on strict one-design.

We will continue to run seven World Championships each year with the aim of moving these around the world to continue to strengthen our position as a global class. Of course, a World Championship in Europe attracts a higher entry, but as a global class we must also go to other continents. In the last two years we have had Worlds in Europe, North and South America, Australia (Oceania) and Asia, with the Under-21s in Africa just over two years ago.

Our World Council is almost entirely made up of volunteers, including each of our Regional Chairs and the President and I would like to thank them, together with all the staff, for their commitment and passion to the class.

We also need to continue to renew. So, I am delighted that Aileen Loo has taken on the role of Vice-President (in addition to her other roles). Also, Virginia Kravaroti will join the World Council as the second European Representative – she is an accomplished sailor and Olympic medallist and will bring a different perspective.

As President, I would like to lead a World Council that listens to our community, is open and responsive and works together to promote our class and the sport as a whole. I look forward to meeting you and thank you for your ongoing support of our class.

Mark Lyttle
ILCA President

Go Sailing, Go Racing

Sailing is great but ILCA sailing is a little bit more special. You are completely in control, and when you want a challenge you go out in stronger and stronger winds until you are flying across waves and through spray, experiencing the most exhilarating ride of your life. When you are able to do that while comparing your skills against other sailors in competition, the excitement is multiplied. The simple joy of ILCA sailing is what launched the boat to success when it was introduced. And it is the fact that you can find active ILCA class sailors all over the world to sail with and compete against that keeps the ILCA dinghy the most popular boat of its type world wide.

If you need a little help learning about the boat there are a number of books and many on-line resources covering all aspects of ILCA sailing and racing. But for many of us, the best way to get to know your boat better is to go racing. It also means you can meet like-minded sailors.

Most of us start by racing in a local fleet. Contact the ILCA Association in your country for details about how racing is organised and where the nearest group of ILCA sailors are (see pages 20-21 or check out the contact list on the ILCA website). Over 90% of ILCA racing takes place during a couple of hours in an evening or on a weekend. Most racing takes place from sailing or water sports clubs and you are almost certain to see a full range of experience at the local club where beginners and experts are welcome. Your club may even organise training weekends and bring in visiting coaches and you will certainly benefit from talking to and watching others.



After a while you may wish to enjoy a weekend or week away, sailing at a different venue against other ILCA sailors. This could be 50 or 500 kilometres away but for sure you will find other places to race. Again, your national ILCA class association can help you identify opportunities.

A National Championship is often the highlight of the annual racing calendar. These events usually are open to all comers and all levels of skill. You can experience the excitement of racing in a large fleet of between 30 and 100+ ILCA sailors. You probably will not become national champion (at least not at the first attempt) but you will certainly have a great time.

With the exception of most World and European Championships, ILCA racing generally has open entry and there are many national and international regattas you can go to with only a limited amount of experience.

In many countries there are events organised specifically for different ILCA rigs (ILCA 4, ILCA 6 and ILCA 7), as well as events for youth and master sailors. Some countries organise extra National Championships for these rigs and age groups.

Contact your national ILCA Class association to find out what activities are available. Check out the contact list on our website at www.ilcasailing.org.

The ILCA Formula

A choice of rigs for different size sailors - 3 boats in one

- *Are your children reaching the age when they want to go sailing in a ILCA by themselves?*
- *Does your partner fancy the occasional sail in your ILCA?*
- *When you drive 2 hours to get to the water have you found it is too windy for you to go sailing?*
- *Are you too light to sail with the ILCA 7 rig?*

The **ILCA Formula** is the answer to all these questions. By changing only the sail and lower mast an ILCA dinghy can be sailed comfortably in a great variety of wind conditions and provide exciting but controlled sailing even for sailors weighing as little as 35 kg. The ILCA Formula is a 3-rig option that has been adopted by a number of sailing schools as a simple and economical way for sailors of different size and ability to sail in a wide range of winds and reduce the amount of 'down time'.

The **ILCA 4** uses a short pre-bent lower mast to maintain a balanced helm and a sail area that is 35% smaller than the ILCA 7. It is ideal for the lighter weight sailor graduating from Optimist.

The **ILCA 6** is the next step up in size. It uses a more flexible and slightly shorter lower mast together with a sail area 18% smaller than the ILCA 7. The ILCA 6 has a large following with national and international regattas and World Championships for Men, Women & Youth attracting as many countries and competitors as the ILCA 7. In addition to having a strong following among lighter weight sailors, the ILCA 6 is also used for youth, women and masters racing. Many countries support a full ILCA 6 Youth program.

The **ILCA 7** can be sailed by any weight in light winds, but as the wind increases it is better suited to higher sailor weights.

Apart from the strong second hand market for the ILCA 7, there is an even stronger second hand market for ILCA 6 and ILCA 4 lower mast and sails as a separate package from the hull.

ILCA 4

SAIL AREA: 4.70m²



ILCA 6

SAIL AREA: 5.76m²



ILCA 7

SAIL AREA: 7.06m²

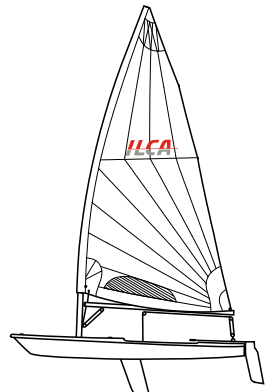

ILCA Policy for Age and Gender

TERMINOLOGY

In referring to the various gender and age groups of competitors, ILCA recommends the following naming conventions:

- Competitors age 19 and over – Men and Women
- Competitors up to age 18 – Youth Boys and Youth Girls.

In written communications, the pronoun “they” may be used instead of “he” or “she” when no other sentence construction is available to avoid using a masculine or feminine pronoun. It is understood that using a plural rather than a singular pronoun is inexact and can cause confusion for the reader, so should be avoided when possible.

WOMEN'S POLICY

ILCA recommends that women’s championships should be held in the ILCA 6.

For identification purposes at certain women’s events, sails must display a red rhombus above the top batten pocket on both sides, as specified in the ILCA Class Rules.

YOUTH AGE POLICY

The ILCA dinghy is widely used as a youth training and racing boat. The chart below illustrates a typical progression and suggested age limits for prizes at youth events. The stepped progression maintains interest throughout youth years for different rates of growth.

For youth events organized by ILCA, a competitor’s category is determined by the age the competitor becomes in the calendar year of the championship.

| Age* | 12 | 13 | 14 | 15 | 16 | 17 | 18 | 19 | 20 |
|--------------|--------------|------|------|----------|----------|----------|------|----------|------|
| Birth Year** | 2014 | 2013 | 2012 | 2011 | 2010 | 2009 | 2008 | 2007 | 2006 |
| ILCA 4 | UNDER 16 | | | | UNDER 18 | | | | |
| | ILCA 6 Youth | | | UNDER 17 | UNDER 19 | | | | |
| | ILCA 6 Women | | | | | UNDER 21 | | | |
| | ILCA 7 Men | | | | | UNDER 19 | | UNDER 21 | |

* The age the competitor **becomes** in the year of the Championship

** The year in which the competitor must have been born **FOR A 2026 CHAMPIONSHIP** using this guide

Within these age limits there will be a wide variation in weight for a given age, therefore some overlap is necessary. The age bands for each rig show suggested main prize categories even when the total entry for a rig is starting together. In larger events, prizes for more age groups within the band limits may be awarded to generate even greater interest.

In general, ILCA recommends that youth events be held in ILCA 4 and ILCA 6. ILCA also supports Under-21 and Under-19 categories (17 - 20 years old in the year of the championship) for the ILCA 7 Men and ILCA 6 Women categories.

Competitors in ILCA Youth World Championships will normally be in the upper age limits and will be capable of sailing at a high level. They should be experienced in big fleets and able to sail well and handle the boat in all conditions, including waves and high winds. Entering a world championship without adequate experience and ability in all racing conditions is not recommended. Importantly, a competitor should be physically capable of righting the boat from a capsized in all racing conditions.

ILCA 6 - policy

With the exception of the world and some continental championships, most ILCA 6 regattas have competitors of mixed genders and ages. However, if there are two or more categories (e.g. category men, category women) with 35 or more sailors in each, it is recommended that these categories race separately and have separate prizes. Where there are separate prize categories, each category may be uniquely identified by a reusable colour band on the mast. When two or more categories race in one fleet, then the individual category results should be extracted from the overall results without rescoring.



ILCA 4

Although the ILCA 4 is used primarily as a youth class, at times it may be appropriate to run “open” ILCA 4 regattas for lighter weight sailors of all ages. At these events, separate category prizes for youth and women should also be considered, in a format similar to the ILCA 6 (item 4 above).

MASTERS - age limits and identification

ILCA's recommended policy for Masters events is that the sailor must reach the ages given in Figure 1 (below), which shall be defined in the Notice of Race.

Determination of age category for Masters World Championships shall be the age attained on the day before the first scheduled race of the regatta.

The colours in Figure 1 are recommended for reusable identification bands on the mast below the gooseneck, so that different category masters know who they are sailing with when they sail in mixed fleets. Overall prizes will be awarded in accordance with the ILCA Honour Award Bylaw in each category.

Fig. 1

| Age Group | Masters Category | Fleet Colour |
|-------------|--------------------------------------|--------------|
| 30 to 44 | Apprentice Master (ILCA 7 / ILCA 6) | Green |
| 45 to 54 | Master (ILCA 7 / ILCA 6) | Red |
| 55 -64 | Grand Master (ILCA 7 / ILCA 6) | Blue |
| 65 - 74 | Great Grand Master (ILCA 7 / ILCA 6) | Yellow |
| 75 and over | Legends (ILCA 6) | White |

HANDICAP NUMBERS

Sometimes we get asked: “What are the handicap numbers for ILCAs in mixed class racing?” The numbers used by the Royal Yachting Association (GBR) in their Portsmouth Handicap system are:

ILCA 7 1104

ILCA 6 1154

ILCA 4 1216

The numbers can be used for handicapping different ILCA rigs within a mixed fleet. To use the numbers, convert the elapsed time into seconds. Divide the elapsed time by the handicap number and multiply by 1000 to achieve a corrected time.

The handicap numbers work best on races around 100 minutes long. Further information on Portsmouth Numbers can be obtained on the internet at: www.rya.org.uk

Personal Handicaps

The handicap numbers take into account the difference in boat speed as a result of the different size rigs but take no account of an individual's ability. If the finishes are timed, a personal factor can be applied to the handicap number so that each person has a Personal Handicap Number.

The handicap numbers are based on race times. In a theoretical race, where an ILCA finished in 60 minutes, an ILCA 6 should finish in 62 minutes 34 seconds if all the sailors were the same standard and made the same mistakes! A Personal Handicap can be introduced by adjusting the handicap numbers.

Personal Handicaps can be fixed for a set number of races or adjusted in any number of ways based on the performance of the last race. For example, if you win a race you are handicapped by 30 seconds in the next race. Second could be handicapped by 15 seconds etc. Similarly, the last placed boat could be given a handicap advantage of 1 minute, second to last 30 seconds etc. A simple time or place penalty system like this can also be used instead of handicap numbers.

It is best to keep race by race changes simple and restrict changes to a maximum of the first two and last two places.

If you decide on a Personal Handicap System don't forget someone has to manage it so KEEP IT SIMPLE.



COACHING AND COACHES

The ILCA Class has been one of the most important platforms for developing sailing talent around the world. Many sailors who have had long and successful careers in ILCA sailing have become coaches to help develop the next generation of ILCA sailors.

ADVERTISING/SPONSORSHIP

Advertising, including competitor advertising, is permitted in accordance with the World Sailing Advertising Code; except that the sail window shall be kept free of advertising or other graphic material in accordance with the ILCA Class rules. Information about the World Sailing Advertising Code can be found at: www.sailing.org

ANTI-DOPING

The latest information about the World Sailing Anti-Doping Code can be found on the World Sailing website: www.sailing.org

What is ILCA?

ILCA is a worldwide sailing organization specifically for owners of ILCA class sailboats and people interested in the sailing them. Like most sailing clubs it is run by volunteer sailors who employ staff to run a dedicated class office.

For easier administration the ILCA Association is divided into 4 main levels of activity, each with elected volunteers:

FLEETS - Normally sailing clubs or small groups of ILCA class sailors sailing together on a local basis. Fleet activities are normally coordinated by a Fleet Captain who has been elected by the sailors in that Fleet.

DISTRICTS - In North America these are single states or an amalgamation of states. For the rest of the world, district boundaries are normally the same as national boundaries, although occasionally small countries either amalgamate with other small countries or get looked after by larger countries. District activities are co-ordinated by a committee, elected by class members at the district's annual general meeting.

REGIONS - These are a number of districts grouped together on a continental basis. Regional activities are coordinated by officers elected by the District representatives.

INTERNATIONAL (World Council) – The World Council operates like the board of directors of a company. It is responsible for directing the work of the association and maintaining the objects of the association as they are expressed in the association's constitution. The World Council consists of officers from around the world with a wealth of experience spread over all levels of sailing.

Contact information for the ILCA office, each Region and all active ILCA class Districts can be found on the contacts page of the ILCA website at www.ilcasailing.org/contacts. Please do not hesitate to contact any officer if you need help or information about ILCA class sailing or the Association.



© Down Under Sail

ILCA Goals

The objects expressed in the constitution of the association are:

- To enhance the enjoyment of ILCA Class sailboats and sailing.
- To provide a means of exchanging information among ILCA sailors throughout the world.
- To promote and encourage ILCA Class racing in all countries under uniform rules.
- To promote and encourage the sporting and recreational aspects of sailing.

ILCA's Work

For the majority of members, the work done by Class officers is not directly apparent, but it is vitally important for the continuation of our class and the very existence of the ILCA sailboat as we know it. It is all too easy to go to a dealer, buy an ILCA, and go sailing with lots of other identical ILCAs without even thinking about how it all happened or if it will continue to happen.

The existence of a strong International Class Association is important to all ILCA owners, whether they are occasional weekend sailors or aiming for an Olympic gold medal. If you doubt this, think back to the reasons why you were originally attracted to the ILCA.

A good design

ILCA cannot take credit for that. However, ILCA plays an important part in protecting that design and making sure it isn't devalued by manufacturing changes. The construction of ILCA equipment is controlled by an agreement between the manufacturers, ILCA and World Sailing, and by the class rules. Monitoring this agreement is an important part of ILCA's work.

Strict one design

When the ILCA was first introduced a set of rules were drafted which, at the time, were very different to other existing classes. These other class rules listed a number of prohibitions, which led to developers trying out new ideas if the idea was not specifically prohibited. The result of this is that quite often older boats became outdated with a subsequent loss in value. The ILCA class rules are different in that they prohibit ANY changes unless the rules specifically allow a change. This means that a 10 year old ILCA is the same as a brand new one and, as a result, holds its resale value far better. ILCA plays an important part in keeping the class rules strictly one design by preventing changes and providing a measurement structure that maintains the one design.

Good racing

The International Office of ILCA is responsible for organising World Championships for the class. Although these events may only involve a relatively small proportion of class members, the organisation of top quality championships has an effect on all sailors around the world. The qualification and training for major championships can only take place at lower level regattas. This results in increased participation at lower levels, which in turn attracts more people to the class. Standards that are set in sailing, racing and organisation at international level filter down throughout our organisation.

Good communication and website

The amount and quality of communication throughout the ILCA Class is very important. ILCA maintains an active website (www.ilcasailing.org) to keep members up to date with important announcement and news about ILCA sailing around the world and serve as repository for helpful information, class rules and historical records. The ILCA maintains a social media presence to engage with sailors worldwide through Facebook, Twitter and Instagram. The office also sends out to all Districts worldwide notices with information to be distributed to sailors. Many Districts send out their own newsletters or maintain a website with information of local interest. Sailors who have questions can easily contact their District representative or the ILCA office through the website. And District officers can of course contact the ILCA office for assistance on matters relating to the class.

Low price

Mass production keeps the price of ILCA Class equipment relatively low. An active class association encourages more people into the class, therefore making mass production viable.

Activity

Whatever reasons made you become an ILCA Class boat owner, they are all a result of ACTIVITY. The Class Association plays an important part in promoting and maintaining this activity and keeping the ILCA at the top of the sailing world for sailors and sailing authorities.

The International Office, together with the regional and district officers, ensure a strong and healthy future for the ILCA.

The International Office also deals with correspondence and communications from individuals, fleets, sailing clubs, district committee members, national yachting authorities, the World Council, World Sailing and the various manufacturing plants - in fact anything concerning ILCA!

***ILCA is working for each individual ILCA sailor
no matter where they are in the world.***



© Down Under Sail

FINANCES

Being a large class, there is a considerable amount of administration. At District level, membership numbers are often so big that part time secretarial help is needed to assist the volunteer officers! Multiply the number of countries by 120 and add together all the memberships from each country, and it is easy to see why we need a full-time International Office.

Any club or association needs a small fee to cover costs. Your membership fee would normally include an amount for the district and sometimes regional administration, plus a contribution towards the international costs of the association. A summary statement of accounts approved by the World Council is made available to members.

The association's finances and administration are independent of the builders, although we work closely together on a number of things. The World Council believes that our continued strength is related to having sound finances, therefore it aims to maintain a reasonable operating surplus each year, which is put in a reserve fund.

ILCA

- A self-administered international organisation
- Provides co-ordination, organisation and communication for the class worldwide
- Liaison with national and international authorities
- Maintains one design rules
- Protects the design and ensures consistency
- Monitors building agreements
- Self-funded
- Positively promotes ILCA sailing worldwide
- Publishes annual handbook
- Organises World Championships at international level
- Administers the class worldwide
- Sets the standard that others aspire to achieve

Website

www.ilcasailing.org

The ILCA website contains a large amount of regularly updated information useful to ILCA owners and sailors, including:

- Event information for all ILCA Class world championships, including dates, allocations, Notice of Race, Charter Terms & Conditions and links to event venue websites.
- Full results, daily results and reports from all ILCA Class World Championships.
- Archive of results from ILCA World & Regional Championships since 1971.
- Facebook.com/intlaserclass / Instagram: https://www.instagram.com/ilca_sailing/
- Bid pages - want to host an ILCA championship? You can find all the bid documents for World championships online.
- Past issues of LaserWorld, are available for all to download or view online.
- Tips and How-to guides that can help you become a better sailor.
- Regularly updated list of addresses for ILCA contacts in each country.

Parts of the ILCA Class dinghy

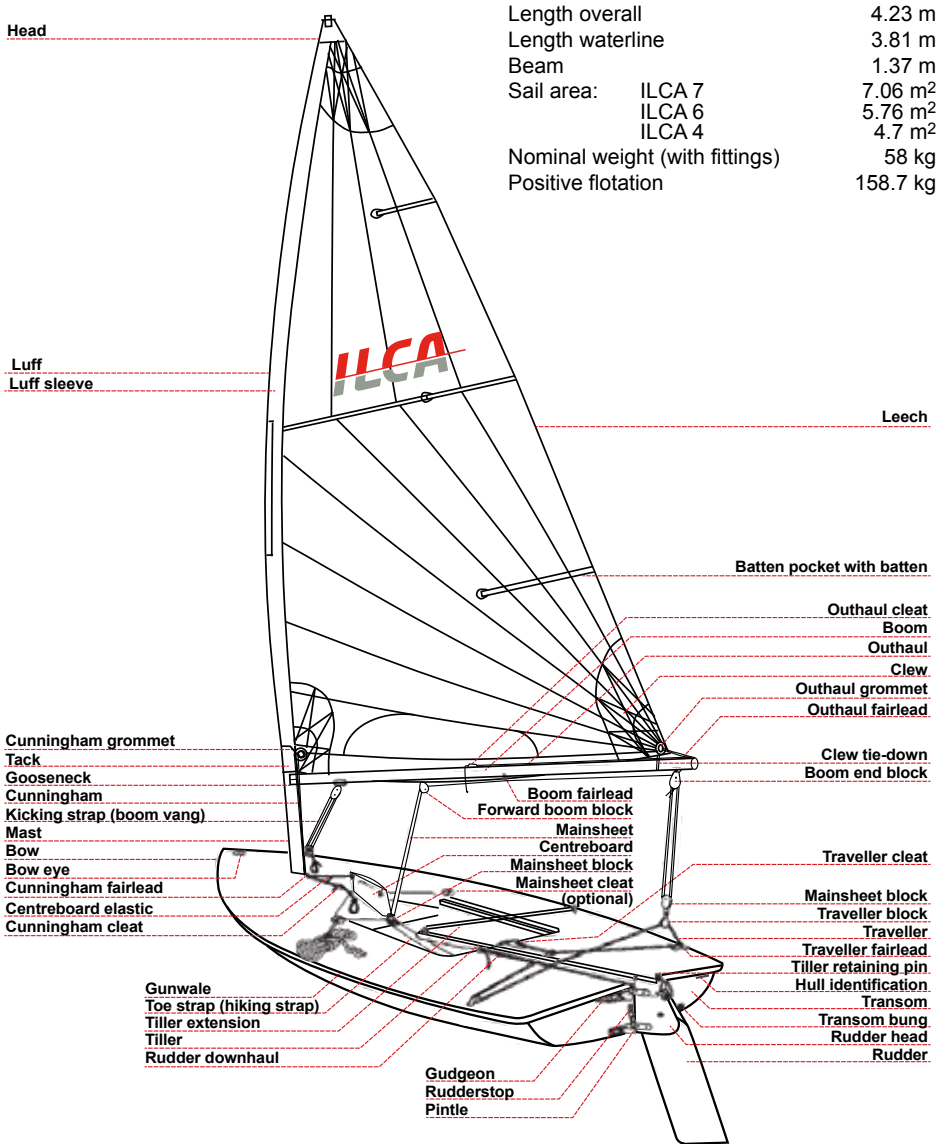

| | |
|--------------------------------|----------------------------|
| Length overall | 4.23 m |
| Length waterline | 3.81 m |
| Beam | 1.37 m |
| Sail area: | ILCA 7 7.06 m ² |
| | ILCA 6 5.76 m ² |
| | ILCA 4 4.7 m ² |
| Nominal weight (with fittings) | 58 kg |
| Positive flotation | 158.7 kg |

ILCA Constitution

© ILCA

Amended 3 May 1974; 18 March 1993; article 12 amended 1 June 1995; articles 6 (1), 7 (4), 8 (3) and 9 (3) amended 1 January 2000; 18 November 2022

1. NAME

The name of the Association shall be ILCA, also doing business as the International Laser Class Association.

2. OBJECTS

The objects of the Association are:

- (1) To provide a medium of exchange of information among ILCA sailors throughout the world and to enhance the enjoyment of sailboats that meet the ILCA class sailboat one-design class rules;
- (2) To promote and develop ILCA class sailboat racing in all countries, under uniform rules; and,
- (3) To encourage and foster the enjoyment of the sporting and recreational aspects of sailing.

3. POLICY

It shall be the policy of the Association to maintain the ILCA class sailboat as the epitome of a strict one-design class of sailboat.

4. JURISDICTION

The Association has authority over all activities of the ILCA class sailboat throughout the world, and its powers shall be vested in and carried out by the World Council, Regional Executive Committees, District Associations and Fleets as provided in this Constitution and any bylaws passed pursuant to the provisions hereof; all subject to and in accordance with the rules and regulations of World Sailing.

ORGANISATION

5. World Council

- (1) The Association shall be governed by the World Council, which shall establish policy and provide oversight for the Association in fulfilling its Objects, and perform the other duties set out in this Constitution.
- (2) Voting members of the World Council shall be the President, the Chairperson of each Regional Executive Committee from time to time holding office, the Builders' Representative to the World Council and any additional members appointed in accordance with clause 5.5 below.
- (3) The World Council shall also include the following non-voting positions as active members and advisors: the Executive Secretary, the Treasurer, the Chief Measurer, the Chief Technical Officer, and any other member invited by the World Council.
- (4) The World Council shall elect annually, by majority vote, from amongst its own members, both voting and non-voting, the President and Vice-President of the Association who shall hold office until they either resign or their successors are elected to office.
 - a. If the elected President is a sitting Chairperson of a Regional Executive Committee or a World Council office holder, that person shall resign as Regional Chairperson or World Council office holder and serve solely in the role as the President of the Association.
 - b. If the elected Vice-President is a sitting Chairperson of a Regional Executive Committee or a World Council office holder, that person shall not resign as Regional Chairperson or World Council office holder.
 - c. The President will serve as the Chairperson of the World Council. In the absence of the President, or in the event of his or her inability or refusal to act, the Vice-President shall perform all the duties of the President.
 - d. The Builders' Representative, the Executive Secretary, or any other paid staff member of the Association or a Builder shall not be eligible to hold the office of President or Vice-President of the Association.
- (5) Any Region that represents more than 40% of the total membership of the Association may nominate an additional voting member of the World Council elected by the Chairpersons of the Districts of that Region.
 - a. The Regional and total membership will be calculated annually and the additional Regional representative will serve an annual term beginning on the subsequent calendar year.
 - b. If a Region's membership drops below 40% of the total membership of the Association, the additional Regional representative shall immediately resign from the World Council.
- (6) The Builders' Representative shall be appointed annually by a majority vote of a representative from each of the approved ILCA builders.
- (7) Each officer, advisor, committee member, and member of the World Council shall be a member of the Association.

- (8) The World Council shall meet not less frequently than once per year. A quorum for any meeting shall be five voting members of the World Council.
- (9) All World Council members shall comply with the ILCA Conflict of Interest Policy.
- (10) The Executive Secretary shall be appointed by the World Council and shall hold office for such term and upon such conditions as the World Council shall decide. The Executive Secretary shall be responsible for the management of all business of the Association, subject to and in accordance with the Constitution, bylaws and the direction of the World Council, including
 - a. the coordination of all inter-regional activities,
 - b. the organisation of all activities relating to World Championships,
 - c. liaison between the Association, World Sailing and all other yachting authorities, and
 - d. liaison between the membership and the Chief Measurer.
- (11) The World Council shall appoint, for such term as it shall decide, a Chief Measurer for the Association who shall rule on all questions and challenges relating to the ILCA Class Rules, and shall issue interpretations thereof as necessary. All such Interpretations shall be binding when duly published to the members of the Association until approved, rejected, or modified by decision of the World Council.
- (12) The World Council shall appoint, for such term as it shall decide, a Treasurer for the Association who shall perform all duties incident to the office of treasurer and such other duties as may be required by law, by this constitution, or that may be assigned to him or her from time to time by the World Council.
- (13) The World Council shall appoint, for such term as it shall decide, a Chief Technical Officer for the Association who shall be responsible for technical control and management of all ILCA approved Builders, managing and maintaining a register of all ILCA approved moulds, and such other duties as may be required by law, by this constitution, or that may be assigned to him or her from time to time by the World Council.

6. Regions

- (1) The World Council may, as and when it deems it convenient for the administration of the affairs of the association within a substantial area where several Districts are or may be established, constitute such area as a Region.
- (2) The World Council, upon establishing a Region, shall appoint a Regional Executive Committee comprised of a Regional Chairperson, Vice Chairperson, and Executive Secretary, to hold office until their successors are elected.
- (3) The Regional Executive Committee shall have those powers, vested in the World Council by this Constitution (other than the power to amend the ILCA Class Rules or this constitution) as are specifically delegated to the Regional Executive by the Regional bylaw, including the power to appoint additional officers for such term as it may from time to time determine.
- (4) The Regional Executive officers, other than the Executive Secretary, shall be elected annually by vote of the Chairperson (or other officer authorised by the Chairperson if he or she is unable to attend) of each District at the annual Regional meeting to be held at the head office of the Region or such other place as the Regional Executive Committee shall determine, and shall hold office until their successors are elected, and nothing shall preclude one of the District Chairpersons as also acting as the Regional Chairperson. Each officer shall be a member of the Association.
- (5) The Regional Executive Secretary shall be appointed by the elected members of the Regional Executive Committee, and shall hold office for such term and upon such conditions as the Regional Executive Committee shall decide. The Regional Executive Secretary shall be responsible for the management of the business of the Region, subject to and in accordance with the Regional Executive bylaw and the direction of the Regional Executive Committee, including
 - a. the co-ordination of inter-District activities and events,
 - b. liaison with the Executive Secretary of the World Council,
 - c. issuance of Fleet Charters,
 - d. maintenance of all records of the Region, and
 - e. maintenance of all membership records and information, unless such duties are delegated to the District Secretary.
- (6) The World Council may subdivide a Region into one or more Regions, may amalgamate two or more Regions or may add Districts to or delete Districts from any Region from time to time as may be required for the effective administration of the Association.
- (7) In the event that a Regional Chairperson shall be unable to attend any meeting of the World Council, the Executive Secretary of the Region or such any other member of the Regional Executive Committee nominated for that purpose may attend and represent the Chairperson and vote at such meeting of the World Council.
- (8) Nothing shall preclude the Executive Secretary of a Region also serving as Executive Secretary of the World Council.
- (9) The Regional Executive Committee may make bylaws, subject to the provisions of this Constitution and the Regional Executive bylaws of the World Council, for any purpose necessary to carry out the functions and responsibilities of such Region, and copies of all such bylaws as are from time to time passed by any Regional Executive shall be filed with the Executive Secretary of the World Council.

7. Districts

- (1) The World Council, on the recommendation of a Regional Executive Committee where applicable, shall by bylaw establish Districts in distinctive areas deemed appropriate and relevant, having regard to all considerations, including geography, language, distance, and population, for the development of the ILCA class sailboat and the fulfillment of the objects of the Association.
- (2) The World Council, upon establishing Districts, shall appoint District Associations comprised of a District Chairperson, a Vice-Chairperson, a Secretary, and a Treasurer, to hold office until their successors are elected.
- (3) The District Association shall consist of the foregoing officers, and may appoint such additional officers to hold office for such term as it may determine. Each officer shall be a member of the Association.
- (4) Each District shall be administered in accordance with and subject to the provisions of a Constitution of the District, approved by the World Council, or if the District has no Constitution, the District Association bylaw of the World Council; and the officers of each District Association shall be elected annually by the members of the Association within the District in accordance with the provisions of the District Constitution, or, in the absence thereof, the ILCA District General Bylaw.
- (5) The boundaries of Districts may be varied by the World Council on the application of any District concerned, and one or more Districts may be amalgamated or any District may be subdivided into one or more Districts with the approval of the District Associations concerned.
- (6) A District Association with the approval of the Chief Measurer may appoint a District Measurer for a District to assist the Chief Measurer in the conduct of his responsibilities and the enforcement of the ILCA Class Rules; and nothing precludes a District Measurer from acting as Measurer for more than one District. A District Measurer shall have the authority to rule on all questions and challenges relating to the ILCA Class Rules and Interpretations of the Chief Measurer, but may not issue Interpretations except with the prior approval of the Chief Measurer of the Association.
- (7) A District Association may make bylaws, subject to the provisions of this Constitution, the Regional Executive bylaws, and the District Association Bylaw or District Association Constitution (as the case may be), for any purpose necessary to carry out its functions and responsibilities in the management of such District.
- (8) If any District is within the jurisdiction of a World Sailing Member National Authority ("MNA"), the District Association shall, in addition to any other requirements of this constitution, be subject to the rules, regulations and directions of such MNA.

8. Fleets

- (1) A Fleet may be granted a charter upon application to the Regional Executive Committee (or the World Council where the locality is outside a Region) by 6 or more members of the Association who are individual owners of ILCA class sailboats within any area or club deemed appropriate, having regard to the locality where regular racing activity is easily accessible to members of that Fleet.
- (2) Notwithstanding the foregoing paragraph, a special Fleet may be chartered in any locality for the purposes of accommodating specific members of the armed forces, an educational institution, a junior programme or any other non-profit organisation.
- (3) A Fleet Captain, and such other officers if any as the Fleet may deem necessary, shall be elected annually from among the members of the Fleet in such manner as is prescribed by the Fleet and shall be responsible to the District Association for the organisation of the Fleet and the due compliance by the members of the Fleet with the provisions of the Constitution and bylaws of the Association. Each officer shall be a member of the Association.

9. MEMBERSHIP

- (1) Any person may become a member of the Association by making application to the Executive Secretary, or the appropriate Regional Executive Secretary or District Secretary, as the case may be, and payment of the prescribed Association dues, provided that he or she has not been disqualified from membership for cause by decision of the World Council or under suspension from membership.
- (2) An application for membership implies that the applicant undertakes and agrees to be bound by the Constitution and bylaws of the Association upon being accepted to membership.
- (3) A member of the Association ipso facto belongs to the District in which he or she normally sails, even though such place may not be his permanent residence; but such member, for valid reason and with the approval of both District Chairpersons, may select instead the District in which he or she has permanent residence.
- (4) A member of the Association may become a member only of the Fleet in his District where he or she normally sails for the purpose of qualification, where required, for sanctioned events; and any dispute shall be settled by decision of the District Association, which decision shall be final.
- (5) The World Council may grant honorary membership in the Association, for such period as it determines, to any person who, through special contribution to the Class or through special relationship to the Association, is considered meritorious.
- (6) The World Council may grant an honorary life membership to any member who has achieved, in the opinion of the World Council, international stature as a result of his yachting achievements.
- (7) An honorary and an honorary life member are entitled to full privileges of membership, but are not required to pay the annual dues of the Association.

- (8) Membership in the Association shall not be open to any company, partnership, group or other association unless specifically authorised in any case or class of cases by the World Council; and the World Council may impose such terms, conditions or qualifications to any such membership as it shall deem appropriate.

10. FINANCES

- (1) Association dues shall be in the amount determined by and shall be payable within the time prescribed by bylaw of each Region or District, as determined by the World Council, and shall include all amounts required for World Council, Region and District purposes as determined by each authority.
- (2) The Association may ask for special contribution in addition to dues, provided any such contribution shall be for a specific purpose and shall not be mandatory.
- (3) Dues shall be collected by the Regional Executive Secretary, but the World Council may direct the District Secretary to collect such dues under such terms and conditions as to reporting and accounting as may be required.
- (4) The Association shall publish independently reviewed annual accounts including a balance sheet and profit and loss statement within six months of the end of its financial year.

11. SUSPENSION AND REMOVAL FROM OFFICE

- (1) A member may be suspended by the World Council, on the recommendation of a District Association, for gross violation of the ILCA Class Rules or bylaws, for committing an unlawful act in relation to the Association or one of its members, or for any unsportsmanlike conduct contrary to the interests of the members of the Association. The duration of the suspension shall be fixed by the World Council and a suspended member shall during such period be precluded from racing or enjoying any other rights of membership.
- (2) A World Council member, an officer or advisor of ILCA, a Regional or District officer, or other representative of ILCA may be removed from office by the World Council for a wilful and unjustifiable act of commission or omission, or derogatory or unprofessional behavior or communications detrimental to the Association, the Objects of the Association, or to its members, employees or volunteers.
- (3) Any action taken by the World Council under this clause requires a two-thirds majority vote.

12. APPEALS

Any dispute arising in relation to fleets, districts, regions, eligibility to race, interpretation of this constitution or the ILCA bylaws or similar matter, other than any dispute as to the interpretation of the ILCA Class Rules or any matter within the jurisdiction of the applicable racing rules, may be made to the World Council whose decision shall be final and binding.

13. TECHNICAL AND MEASUREMENT COMMITTEE

- (1) The World Council shall appoint a Technical and Measurement Committee, the membership of which shall comprise the President, the Chief Measurer, the Chief Technical Officer and a Builders' Representative.
- (2) The committee shall be responsible for managing and amending the ILCA Build Manual and reviewing and making recommendations to the World Council on any proposed technical developments or changes to the ILCA Class Rules.

14. BYLAWS

The World Council may make bylaws for the purpose of carrying out the objects of this Constitution and of the Association and, without restricting the generality of the foregoing, may make bylaws

- (a) amending the ILCA Class Rules, hereby established as bylaw 1 of the Association, as provided in paragraph 31 thereof;
- (b) respecting the establishment of Regions, and the powers of the Regional Executive Committees;
- (c) delegating specific powers of the World Council to Regional Executive Committees;
- (d) respecting the establishment of Districts and the powers of District Associations;
- (e) respecting the Constitution and bylaws of District Associations;
- (f) respecting registration of members and collection of dues;
- (g) respecting the measurement of boats and measurement fees;
- (h) respecting the conduct of championship and other regattas, including the classification of regattas and the eligibility of members for major racing events;
- (i) respecting the acceptance of deeds of gift of trophies; and
- (j) respecting the procedures for meetings of the World Council and Regional Executive Committees, including the conduct of business by mail or other means of communication.

15. AMENDMENTS

Amendments to this Constitution shall require two-thirds majority approval by each of:

- (a) the World Council, and
- (b) the membership replying to a ballot published from the Head Office of the Association. Only those votes received within three months from the date of publication of the proposed change shall be valid.

Protecting the One Design Principle

An overview of the tools we have to protect the One Design Principle and how each member of ILCA can influence changes to the Rules and the ILCA Build Manual

The one-design principle is the most important asset of the ILCA. Its protection is therefore a prime concern for the class. A number of instruments are in place to assure that protection. The most important ones are the ILCA Build Manual (IBM) and the ILCA Class Rules.

The IBM is a proprietary, protected document that specifies the manufacturing procedures, standard plugs and tools as well as the raw materials and parts supplied by third parties for the hull, sails and spars. Periodic factory inspections by the class make sure that the manual is strictly adhered to by the builders. These factory inspections are the “measurements” in the traditional sense of sailing. The class rules specify that nothing can be changed by a sailor on the hull, sail and spars except what is specifically and positively allowed by the rules. At major ILCA regattas, there is no measurement in the traditional sense. Instead, a simple inspection is made to assure that only original parts are used and that the boat is rigged according to the rules.

The one-design principle means that all ILCA Class boats produced by the approved builders are the same. There should be no differences in performance, quality and fittings used between boats from different manufacturers. The IBM is the instrument to assure this. It defines in detail the manufacturing procedures, the materials used and the quality assurance procedures mandatory for each builder.

Several years ago, the ILCA undertook a major revision of the IBM to bring it into compliance with current practice. Wherever possible tolerances were reduced, more detailed descriptions were added and the whole manual was put into a properly secured electronic form. The IBM is continuously reviewed as part of an ongoing process to further tighten tolerances and specifications where possible.

During the revision of the IBM much thought was given to the basic principles on how the ILCA should evolve. The following principles were approved by all the builders and the ILCA and are now part of the IBM:

Evolution in quality and ease of use:

The builders have made and will continue to make a sustained effort to improve the quality, durability and ease of use of the ILCA – but without changing its basic performance. Where tolerances exist in the quality assurance procedures for incoming materials and for the manufacturing process, a continued effort will be made to reduce them, but avoiding significant cost increases.

The concept of a "lead builder":

For each proposed project a “Lead Builder” will be nominated, who will report periodically to the other builders and ILCA. Changes can only be introduced after the appropriate testing and with the approval of all of the parties concerned.

Between 2022 to 2025 the Technical team has over quadrupled - Along with the 10 approved builders, this team has improved the quality of the ILCA dinghy to exceed the expectations of World Sailing and all levels of sailor. This has involved a continuing further refinement of the specifications, tooling, materials and procedures within the IBM.

© ProwMedia



Availability of options in materials and fittings:

If the IBM or the class rules allow options in the fittings, boat parts and material used, then all options should be made available worldwide at the same time and at comparable prices.

Evolution of the ILCA Class dinghy:

Allow only for changes that are not too expensive, do not affect the performance of the boat and can be easily fitted by a sailor without professional help.

Parts or fittings that have been produced in compliance with the IBM and are therefore legal under the rules cannot be subsequently made illegal, but restrictions on the use of particular equipment (in the interest of minimising differences) may be made.

The control of the adherence to the IBM is governed by the Approved Builder Agreement which defines the procedures for the periodic factory inspections by the class and the measures necessary in case of deviations. This agreement, alongside the Class Rules, holds the whole "ILCA one-design system" together.

The Rules:

The basic principle is that nothing can be changed by a sailor on a ILCA Class dinghy, which was built according to the tight specifications of the IBM. Only a few changes, which are positively described in the rules, are allowed. The rules also describe how a boat must be rigged to be class legal. Sometimes a rule may seem ambiguous, with different people disagreeing about the meaning of a rule. In these situations, the Chief Measurer of the Class publishes in the Handbook as well as on the ILCA website interpretations to certain rules. Some of these interpretations may end up becoming a permanent part of the class rules through the rule change process.

Over the years changes have been made to the ILCA and the IBM and the rules have evolved. When considering changes, the class and the builders have been very careful that:

- The changes do not affect the basic performance of the boat, but
- Only the ease of use, durability and safety were improved and
- Older parts, fittings and sails remain legal

How can each member of ILCA influence these changes?

Firstly, be aware that only changes which improve the ease of use, durability, or safety of the boat have the chance to be passed.

Rule changes:

If you have a good idea for a rule change, talk first to some other sailors and also to class officials to see whether they share your opinion. If this is the case, then formulate the rule change as precisely as possible and add a justification. Next, send your proposal to the ILCA office. Proposals will be forwarded to the Chief Measurer and the members of the Technical and Measurement Committee who, after considering the proposal, may put the matter before the World Council. Finally, if the World Council agree, the rule change must be approved by two thirds of the membership. It may seem like a lengthy process but it helps insure that the one design nature of the class is maintained while still allowing for improvements in ease of use, durability and safety in order to enhance our sailing and racing experience.

Changes in the ILCA Build Manual:

In view of the protection of the one-design principle, there is always much hesitancy to change the IBM. Any change must have clear and important advantages in terms of usability, quality, durability or safety. Any proposal must be duly justified.

The best way to get some attention is to present a detailed proposal to the Technical and Measurement Committee through the ILCA Technical Officer. Be aware that any change requires the approval of both ILCA and World Sailing, but is not subject to a member vote. Despite the high hurdles a change must overcome before it can take effect, there are several examples in the last few years of important changes that were initiated by ILCA members. If you have a good idea for improving the boat, we would like to hear from you.

ILCA Member Districts 2026

For the
For No



ALGERIA
AMERICAN SAMOA
ANDORRA
ANGOLA
ANTIGUA
ARGENTINA
AREMENIA
ARUBA
AUSTRALIA
AUSTRIA
AZERBAIJAN
BAHAMAS
BAHRAIN
BARBADOS
BELARUS*
BELGIUM

BELIZE
BERMUDA
BRAZIL
BRITISH VIRGIN ISLANDS
BULGARIA
CAMBODIA
CAYMAN ISLANDS
CHILE
CHINA
CHINESE TAIPEI
COLOMBIA
CROATIA
CUBA
CYPRUS
CZECH REPUBLIC
DENMARK

DOMINICAN REPUBLIC
ECUADOR
EGYPT
EL SALVADOR
ESTONIA
FIJI
FINLAND
FRANCE
GERMANY
GIBRALTAR
GREECE
GUAM
GUATEMALA
HONG KONG CHINA
HUNGARY
ICELAND

INDIA
INDONESIA
IRELAND
ISRAEL
ITALY
JAMAICA
JAPAN
KAZAKHSTAN
KENYA
KOREA
KUWAIT
LATVIA
LITHUANIA
LUXEMBOURG
MACAU CHINA
MALAYSIA

For the most up to date list of districts, please visit www.ilcasailing.org/contacts/districts/
 For North American districts, please visit <https://ilcanasailing.org/districts>

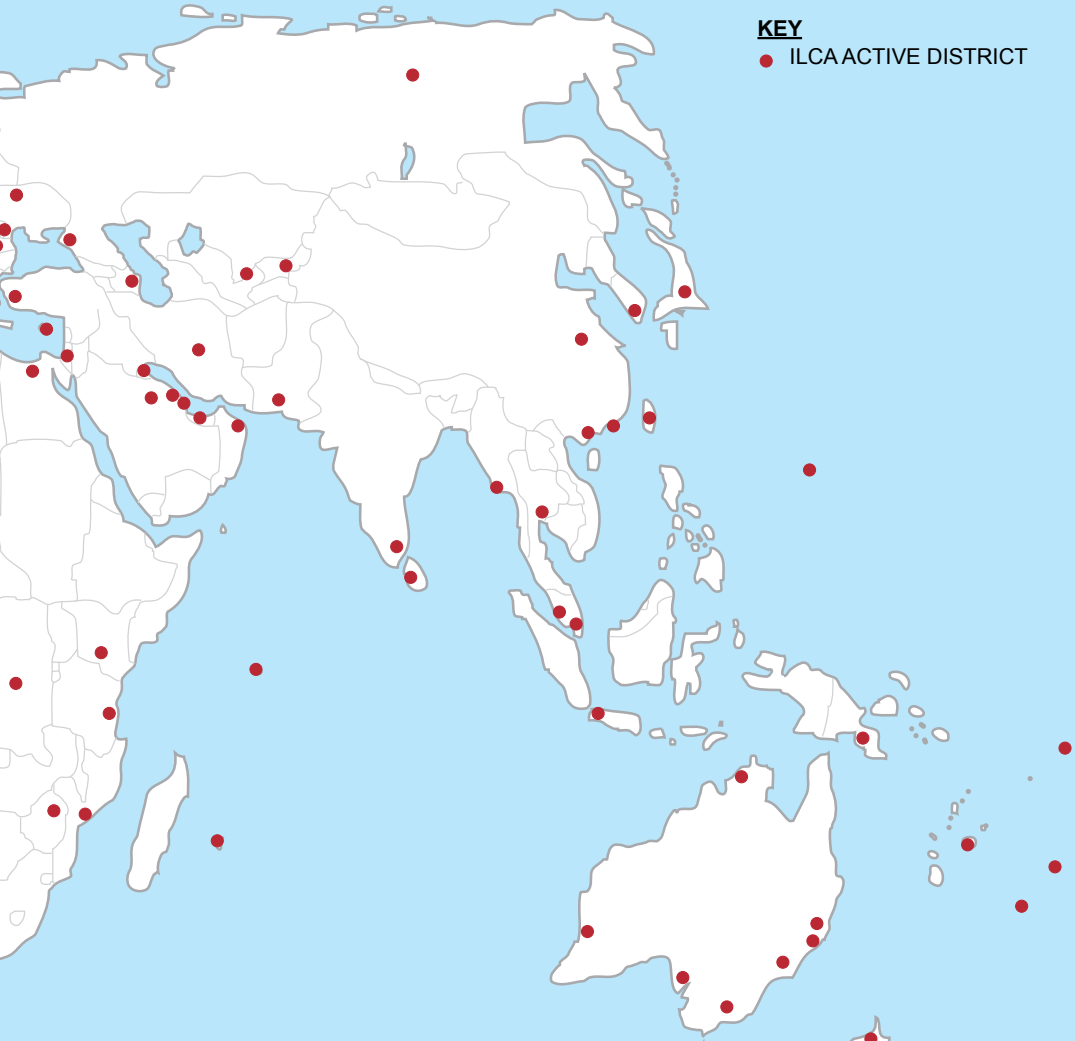

KEY

● ILCA ACTIVE DISTRICT

MALTA
 MAURITIUS
 MEXICO
 MOLDOVA
 MONACO
 MONTENEGRO
 MOROCCO
 MOZAMBIQUE
 MYANMAR
 NETHERLANDS-
 ANTILLES
 NETHERLANDS
 NEW ZEALAND
 NIGERIA
 NORTH AMERICA
 NORWAY

OMAN
 PAKISTAN
 PANAMA
 PARAGUAY
 PERU
 PHILIPPINES
 POLAND
 PORTUGAL
 PUERTO RICO
 QATAR
 REPUBLIC OF -
 NORTH MACEDONIA
 ROMANIA
 RUSSIA*
 SAMOA
 SERBIA

SEYCHELLES
 SINGAPORE
 SLOVAKIA
 SLOVENIA
 SOUTH AFRICA
 SPAIN
 ST LUCIA
 St VINCENT &
 THE GRENADINES
 SWEDEN
 SWITZERLAND
 TAHITI
 TANZANIA
 THAILAND
 TRINIDAD & TOBAGO
 TUNISIA

TURKEY
 TURKS & CAICOS
 UGANDA
 UKRAINE
 UNITED ARAB EMIRATES
 UNITED KINGDOM
 URUGUAY
 US VIRGIN ISLES
 VENEZUELA

* Pending World Sailing approval

Boat Care - Stresses and Strains

The ILCA dinghy has an excellent record of durability, but like any piece of equipment it can break if overstressed. Weight for weight it probably has one of the strongest constructions of any boat of its type, a fact we are all aware of on occasions when we see ILCAs over 20 or more years old, sailing happily when other boats are retired to the scrap heap. Further, the ILCA has proved itself in very strong winds when other classes are reduced to wreckage. It never ceases to amaze us to see ILCAs sailing in 40 knots plus.

Over the years, small changes have been made to the boat to strengthen it as we sail in increasingly challenging conditions. However, there is a limit to the number or kind of changes that can be made before performance is affected.

Mast

When the ILCA was introduced, and for many decades after, the two part aluminium mast design involved a trade-off between strength, stiffness and weight. Any increase in strength of the mast would dramatically affect stiffness and therefore performance, which would be totally undesirable.

Today, many ILCA masts are produced from composite materials, and aluminium spars are made to a very high manufacturing standard in the for the specified wall thickness. Within this standard the Class requirements demand an even tighter tolerance. Even with this high standard it is possible, when sailing, to stress the mast beyond its yield point which causes a permanent bend.

Some of the biggest causes of bending are sailing with a lot of boom vang on and:

- 1) capsizing at speed;
- 2) catching a wave with the boom end, either offwind or while gybing; or
- 3) sailing into the back of a wave causing rapid deceleration.

Recognising these causes tells us that it is very important to release the boom vang before sailing offwind, ideally just before you round the windward mark. In strong winds, this will reduce the risk of bending with the added advantage that you will open up the leech of the sail which is fast for offwind work! As a guide for letting off the boom vang, trim the mainsheet tight until the rear boom and traveller blocks are just touching then release the vang until there is no pressure on it.

While the above can help you reduce the chance of causing a permanent upper mast bend, sailors seem intent on pushing the ILCA harder and longer in ever more challenging conditions.

In 2017 Class equipment manufacturers introduced a class approved composite upper mast section. The composite mast, while having performance characteristics similar to the aluminium top mast, is not subject to permanent bending. Like any piece of sailing equipment, it is not indestructible, but the composite top mast should provide sailors with a longer mast life and consistently reliable performance when out racing, training or pleasure sailing. The composite ILCA 6 lower mast was introduced in 2020 and is class legal for competition.



Rudder and Tiller

Rudders and tillers like everything else are not indestructible. On the very few occasions when we have seen damage to either the rudder or the tiller, it has been caused by trying to bear away at speed while the ILCA is heeled to leeward. When an ILCA is heeled over it takes on severe weather helm. If you try and bear away whilst heeled, you place great loads on the rudder and tiller. The simple answer is to bring the boat upright first before attempting to bear away. This can be done by either hiking more and/or releasing the mainsheet.

ILCA Class Rules - One Design

One of the attractions of the ILCA Class for most owners is that the class rules are very strict and that the boat is one-design. The Class philosophy incorporated in the rules is that we want to go sailing, not waste time fiddling with boats. We want to win races on the water using our skill, not by trying to find a way around the rules that will give us an advantage.

The class rules are written to prevent any changes from the manufactured boat that might affect performance, so that on the water each boat is the same. The few changes to the standard boat that are allowed are minor and only allow a few options that make racing the ILCA more comfortable and enjoyable.

Over the years the class has refused to make changes to the rules that allow more expensive or complicated equipment or that makes older boats redundant.

If you feel you want to change something on an ILCA Class boat - STOP. Ask yourself why you want to do it? If the answer is "to make me go faster" there is a very good chance the modification or addition is illegal!

Take a look at the Class Rules.

- Part One explains the Fundamental Class Rule which covers the philosophy and any item not specifically written into the rules.
- Part Two tells you what you must do to have a legal boat.
- Part Three details a few optional changes and additions you can make.

If Part Three does not specifically allow a change or addition - IT IS ILLEGAL!

If you race a boat that has a change or addition not allowed by the class rules you will be disqualified from the race. Ignorance of the rules is no defense.

Cheating

In our sport in every club and class there is the odd person who needs to cheat to win. Cheating is doing something that you know is against the rules. Whether you gain an advantage or not is irrelevant.

Our class is strong and popular because we believe in a strict one design and our sailors want to know that they are racing on equal terms. ILCA takes a very strong line with competitors who do not sail according to the Class rules. There have been cases in the past where sailors who have sailed with illegal boats have been banned from competing in ILCA Class events. Such a ban can be for life. If action is also taken under the racing rules, the ban can cover racing in any boat.

Our class is much bigger than the odd person who wants to gain an advantage by illegally changing the ILCA or its equipment. They can sail in other classes where the rules allow changes to a boat to get an advantage. We do not want them with us.

Class Rules Index

| | | |
|-----------------------------------|--------------------------------|-----------------------------------|
| PART ONE | 8. Hull Coatings.....28 | 21. Clips & Storage Bags30 |
| Object.....24 | 9. Class Association | 22. Compass30 |
| Fundamental Rule24 | Membership.....28 | 23. Wind Indicators.....30 |
| Hull Identification24 | 10. Advertising.....28 | 24. Tape and Line.....30 |
| Definition of a Builder24 | | 25. Safety Equipment.....30 |
| PART TWO | PART THREE: | 26. Repairs & Maintenance30 |
| 1. Measurement Diagrams.....24 | 11. Hull Finish.....28 | 27. Reefing30 |
| 2. Measurement24 | 12. Transom Drain Bung28 | 28. Boat or Body |
| 3. Control Systems, | 13. Self Bailer.....28 | Mounted Camera.....30 |
| Control Lines and Fittings.....24 | 14. Centreboard28 | |
| 4. Sail Registration Numbers, | 15. Rudder.....28 | PART FOUR |
| National Letters & Flag.....26 | 16. Tiller.....29 | 29. ILCA 6.....30 |
| 5. Mast.....27 | 17. Hiking Strap.....29 | 30. ILCA 4.....31 |
| 6. Clothing and Equipment.....27 | 18. Boom.....29 | |
| 7. Sailing Requirements28 | 19. Mast.....29 | PART FIVE |
| | 20. Inspection Ports.....30 | 31. Amendments31 |

The latest edition of the ILCA Class Rules and Bylaws are available at www.ilcasailing.org.

ILCA Class Rules

(Parts one to five inclusive)

Valid from 21st August 2023. Cancels all previous rules and interpretations.

RECENT CHANGES:

21st August 2023

Rule 3(d)x modified to remove photographs and 3(d)x.d) was added to allow replacement of certain specified parts.

13th February 2023

Rule 24 modified to allow heat shrink tube

1 January 2020

Definition of Builder modified. Other class rules affected by this rule change were modified to be consistent with the amended definition of Builder.

1 January 2019

Part One modified to clarify that all sails used in competition shall have an ILCA supplied sail button to be class legal. (previous interpretation.)

Rule 3(b)i modified to remove the restriction on the use of aramid fibre rope for control lines. (previous interpretation)

Rule 3(b)ii modified to allow for local variation in thickness of control lines that is not specifically restricted to tapering. (previous interpretation)

Rule 3(b)vi modified to enable clam cleats to include a through hole attachment point. (previous interpretation)

Rule 19(a) modified to clarify that mast step abrasion tubes or collars may be in separate pieces. (previous interpretation)

Rule 31 modified to shorten the rule voting process from six months to one month and removing "votes to be sent by post".

1 January 2017

Rule 22 Compasses, Electronic Equipment and Timing Devices modified to allow use of digital compasses that are not GPS enabled.

New Rule 28 Added to allow boat or body mounted cameras.

Rule 3(f)vi modified to remove restriction on the attachment points of the shock cord inhaul.

Rule 17(c) modified to allow for the addition of one cleat and one turning point in the hiking strap support line that are not attached to the hull or hiking strap.

INTRODUCTION

The principle of the ILCA Class Rules is that no changes to the boat are allowed unless they are specifically permitted by the class rules.

The English text of the ILCA Class Rules shall govern.

PART ONE

OBJECT

The boat is a strict one-design dinghy where the true test, when raced, is between helmspersons and not boats and equipment.

FUNDAMENTAL RULE

The boat shall be raced in accordance with these Rules, with only the hull, equipment, fittings, spars, sail and battens manufactured by a World Sailing and International Laser Class Association (ILCA) approved builder in strict adherence to the boat design specification (known as the Construction Manual) which is registered with World Sailing.

No addition or alteration may be made to the hull form, construction, equipment, type of equipment, placing of equipment, fittings, type of fittings, placing of fittings, spars, sail and battens as supplied by the builder except when such an alteration or change is specifically authorised by Parts 2 or 3 of these Rules.

HULL IDENTIFICATION

All boats shall have an identification number moulded into the deck under the bow eye or into the transom, which shall be either the sail number or a unique production number.

Boats with sail numbers from 148200 shall display a unique World Sailing Building Plaque that has been purchased by the builder from the International Laser Class Association. The plaque shall display the sail number of the boat issued by the International Laser Class Association and shall be permanently fixed in the rear of the cockpit by the builder.

SAIL IDENTIFICATION

Sails manufactured after 1 January 2001 shall have attached near the tack of the sail an ILCA authorized sailmaker button purchased from the International Laser Class Association. ILCA 7 MKII sails shall have orange buttons and ILCA 6, ILCA 4 and ILCA 7 MKI (cross-cut) sails shall have red buttons.

DEFINITION OF BUILDER

A Builder is a manufacturer that is manufacturing the hull, equipment, fittings, spars, sails and battens in strict adherence to the Construction Manual, and has been approved as a Builder by each of World Sailing and the International Laser Class Association.

PART TWO

1. MEASUREMENT DIAGRAMS

The Measurement Diagrams are part of these Rules.

The spars, sails, battens, centreboard, rudder, and the placing of fittings and equipment shall conform to the Measurement Diagrams. The measurement tolerances are intended to allow for necessary manufacturing tolerances and shall not be used to alter the design.

2. MEASUREMENT

In the case of a dispute alleging non-compliance with the Construction Manual, the matter, together with any relevant information, shall be referred to the Chief Measurer of the International Laser Class Association at the International Office who shall give a final ruling in consultation with a World Sailing Technical Officer.

In the case of a measurement dispute on the hull, spars, sail, battens, centreboard and rudder, rigging, type of fittings and equipment and the placing of same not explicitly covered by these Rules, Measurement Diagrams and Measurement Bylaws the following procedure shall be adopted:

A sample of 10 other boats shall be taken and measured using identical techniques. The dimensions of the disputed boat shall be equal to, or between the maximum and minimum dimensions obtained from these 10 boats. If the boat in question is outside these dimensions the matter, together with any relevant information, shall be referred to the Chief Measurer of the International Laser Class Association at the International Office, who shall give a final ruling. If any of the dimensions of the sample are considered to be unusual, all relevant information shall be referred by the Class Association to World Sailing.

3. CONTROL SYSTEMS, CONTROL LINES AND FITTINGS

(a) Control System Definitions

- i The Cunningham, outhaul, vang, traveller and mainsheet are the **Control Line Systems**. The cunningham, outhaul and vang **Control Line Systems** may include more than one **Control Line** as allowed in Rules 3(d), 3(e) and 3(f)
 - i. Each **Control Line** shall be a single piece of uniform thickness and material. A line is a **Control Line** if any of the line moves along its axis during adjustment of the **Control Line System**. A line that exclusively attaches items together is a **Tie Line**.
- ii For the purpose of these definitions, the **Standard Fittings** are the:

| | |
|-------------------------------|------------------------------|
| Plastic cunningham fairlead | Vang cleat block |
| Plastic cunningham clam cleat | Vang key block |
| Plastic outhaul clam cleat | Vang key |
| Plastic outhaul fairlead | Plastic traveller clam cleat |
| Plastic traveller fairleads | Mainsheet block |

- iii An “**Optional**” fitting is a fitting or block that replaces, or is additional to, a **Standard Fitting** as allowed by these Rules.
- iv A “**Builder Supplied**” fitting replaces a **Standard Fitting**, and is supplied only by the Builder, as allowed by these Rules.
- v A “**Turning Point**” is a sheave (pulley) in a block, a rope loop, a rope loop reinforced with a thimble, the outhaul fairlead, a shackle, part of a fitting, sail cringle, mast or boom around which a moving **Control Line** passes, **except that the cunningham fairlead, the “Optional” blocks attached to the “Builder Supplied” deck block fitting, the cunningham clam cleat, and the “Optional” cam cleats attached to the “Builder Supplied” deck cleat base will not be counted as “Turning Points”** in Rules 3(e)i and 3(f)i.
- vi When an “**Optional**” block, or shock cord is **attached** to a fitting, line, mast, boom or the sail, it may be attached either with or without a shackle, clips, balls, hooks and/or a tie line.

(b) Control Lines and Fittings

- i. Control lines shall be natural or synthetic rope.
- ii. Control lines shall be of uniform thickness, but may vary in thickness for the purpose of a splice at the load bearing attachment point.
- iii. In a control line system where more than one control line is permitted, lines of different diameter shall not be joined together.
- iv. “Optional” blocks allowed in cunningham, vang or outhaul control systems, shall have sheaves of diameter not less than 15 mm and not more than 30 mm.



- v. Thimbles allowed to reinforce rope loops used as “Turning Points” in the cunningham, vang and outhaul control line systems shall not exceed 40mm in length.
- v. Only single or double “Optional” blocks shall be used. A single block means a block with one sheave; a double block means a block with two sheaves. “Optional” blocks may include a becket, a swivel and/or a shackle.

- vi. The fairleads and clam cleats may be replaced in the same position with an identical size and shape fitting. Clam cleats may include a through hole attachment point.
- vii. The plastic cunningham fairlead may be replaced with one of the same type which has a stainless steel insert, and has the same screw hole positions.



- viii. “Builder Supplied” Deck Fittings (Deck Block Fitting and Deck Cleat Base)

- a) The cunningham fairlead may be replaced in the same position with a “Builder Supplied” deck block fitting which may have one or two single “Optional” blocks attached.



“Optional” blocks shall not be attached to the cunningham fairlead.

Either the cunningham fairlead alone, or the “Builder Supplied” deck block fitting with single “Optional” block(s) attached may be used to lead the cunningham and/or outhaul control lines to the deck cleat(s)

- b) The “Optional” deck blocks may be supported with a spring, ball, plastic tube or tape.
- c) The cunningham clam cleat may be replaced

in the same position with a “Builder Supplied” deck cleat base for attaching two “Optional” cam cleats (cunningham and outhaul) which have fixing hole centres of 27 mm.



The two cam cleats may include a bridge and a fairlead with or without rollers on the aft exit.

- d) Control lines shall not be tied to any of the cunningham fairlead, the “Builder Supplied” deck block fitting and the “Optional” blocks attached to it, the cunningham clam cleat or the “Builder Supplied” deck cleat base and the “Optional” cam cleats, cleat bridge and fairleads attached to it.
- ix. Rope loop handles covered with plastic/rubber tube and/or tape may be included anywhere on the free end of a control line.
- x. The free ends of different control lines (except mainsheet) may be tied together and/or tied to any deck fitting or the centreboard, the centreboard handle or a rope loop used to attach a retaining line. Free ends of control lines shall not be tied to shock cord (except mainsheet).
- xi. To secure the mast in the event of a capsized, a loose retention line or shock cord (that will allow 180 degree plus mast rotation) shall be tied/attached between the cunningham fairlead or the deck block fitting and the mast tang or gooseneck. Clips, hooks, shackles and balls may be used to attach the retention line.
- xii Reference points (marks) may be placed on the deck, spars and ropes.

(c) Mainsheet – also see Rules 3(a) & 3(b)

- i. The mainsheet shall be a single line, and be attached to the becket of the aft boom block, and then passed through the traveller block, the aft boom block, boom eye strap, forward boom block and the mainsheet block. After the mainsheet block it shall be knotted, or tied, so that the end of the mainsheet cannot pull through the mainsheet block. The mainsheet shall not be controlled aft of the forward boom block except to facilitate a tack or gybe.
- ii. The tail of the mainsheet may also be knotted or tied to either the base of the mainsheet block, the hiking strap, the hiking strap support line, or the hiking strap shock cord. This option, if used, satisfies the knotting requirement in 3(c).
- iii. The mainsheet block may be replaced by any type of single block with or without an internal or attached jamming device, and mounted in the position shown on the measurement diagram. The block may be supported by a spring, ball, plastic tube or tape.
- iv. One mainsheet clam or cam cleat of any type may be mounted on each side deck in the position shown on the measurement diagram.

(d) Vang – also see Rules 3(a) & 3(b)

- i. The vang system shall be between the mast tang and the boom key fitting and shall be comprised of the vang cleat block, the vang key block, a maximum of two control lines, loops and/or “Optional” blocks for additional purchase with a **maximum of 7 “Turning Points”**.
- ii. The vang cleat block shall be attached directly to the mast tang, or to an “Optional” swivel that shall be attached to the mast tang.
- iii. A shackle may be used to attach the vang cleat block or the swivel to the mast tang.
- iv. The swivel, shackle or swivel/shackle combination shall not exceed 80 mm in length when measured under tension.

- v. The vang key block may be fitted with a spare key.
 - vi. The key may be straight or bent, and it may be held in the key way with either tape, elastic or velcro.
 - vii. The vang key block may be replaced with an "Optional" vang key block which may have a spare key.
 - viii. "Optional" "single blocks may be attached to one or both sides of the vang cleat block, using a clevis pin or bolt through the attachment hole in the vang cleat block.
 - ix. The mast tang hole may be drilled to take a larger pin.
 - x. "Builder Supplied" Vang Cleating Fitting
 - a) The Vang cleating fitting may be replaced with a "builder supplied" vang cleating fitting which incorporates "turning points" and a cam cleat.
 - b) The fitting shall be attached directly to the mast tang.
 - c) The fitting shall not be modified in any way except as permitted in (d)
 - d) Fairleads, cleats, attachment pins & rings may be replaced with parts of equivalent shape, size, weight, and function..
- (e) Cunningham – also see Rules 3(a) & 3(b)**
- i. The cunningham system shall consist of a maximum three control lines, "Optional" blocks or loops for purchase with a **maximum of 5 "Turning Points"**.
 - ii. The cunningham control line shall be securely attached to any of the mast, gooseneck, mast tang, swivel or shackle that may be used to attach the vang cleat block to the mast tang, the cunningham attachment point on the "Builder Supplied" vang cleating fitting or the becket of an optional becket block fixed on the cunningham attachment point on the 'Builder-supplied' vang.

The cunningham control line shall pass through the sail tack cringle as a moving line.

The sail tack cringle shall be at least one of the **maximum of 5 "Turning Points" permitted by Rule 3(e)i.**
 - iii. Additional purchases may be obtained using rope loops, "Optional" blocks and using any of the boom, sail tack cringle, gooseneck fitting, mast tang, shackle attaching vang cleat block or swivel, the swivel, or the cunningham attachment point on a "Builder Supplied" vang cleating fitting.
 - iv. Deck Block Fitting and Deck Cleat Base

The cunningham control line shall pass only once through the cunningham fairlead or "Optional" single block attached to the "Builder Supplied" deck block fitting and shall pass only once through the cunningham clam cleat or "Optional" cam cleat attached to the "Builder Supplied" deck cleat base.
- (f) Outhaul – also see Rules 3(a) & 3(b)**
- i. The outhaul system shall consist of a maximum of two control lines, "Optional" blocks or loops for purchase and a **maximum of 6 "Turning Points"**.
 - ii. The outhaul control line shall be attached to either the end of the boom, the outhaul fairlead, the sail, or a quick release system, and shall pass through the boom outhaul fairlead as a moving line at least once.
- The outhaul fairlead shall be at least one of the maximum of 6 "Turning Points" permitted by Rule 3(f)i.
- iii. Additional purchases may be obtained by forming rope loops in the line or adding "Optional" blocks to the line, and/or using the outhaul fairlead, the outhaul clam cleat, the boom, the mast or gooseneck fitting.

An "Optional" block may be attached to the outhaul fairlead, **provided** Rule 3(f)ii is also satisfied.

An "Optional" block may be attached to the outhaul clam cleat.
 - iv. An "Optional" block may be attached to the clew of the sail, or to a quick release system, or be part of a quick release system.
 - v. One or two "Optional" blocks may be attached to the gooseneck fitting, or at the mast/gooseneck junction with their "Turning Points" not more than 100mm from the centre of the gooseneck bolt. (The gooseneck may be inverted.) The blocks in this rule may also be attached to the gooseneck with a bolt or a pin.
 - vi. A shock cord may be used as an inhaul on the clew
 - vii. Shock cord and/or rope loops (rope loops may be part of the control line) can be tied around the boom and/or the outhaul control lines to retain the outhaul lines close to the boom.
 - viii. Deck Led Outhaul System
 - a) When led to the deck, the outhaul control line shall pass only once through the cunningham fairlead or the outhaul "Optional" single block attached to the "Builder Supplied" deck block fitting and shall pass only once through the "Optional" cam cleat attached to the "Builder Supplied" deck cleat base.
 - b) The boom outhaul clam cleat shall not be removed.
- (g) Clew Tie Down – also see Rules 3(a) & 3(b)**
- i. The clew of the sail shall be attached to the boom by either a tie line or a webbing strap with or without a fastening device wrapped around the boom and through the sail cringle, a quick release system attached to a tie line or soft strap wrapped around the boom, or a "Builder Supplied" stainless steel boom slide with quick release system. An additional outhaul extension tie line may be added between the clew of the sail and the outhaul or the quick release system.
 - ii. If the clew tie down is a tie line, it may be passed through solid balls with holes and/or tubes to reduce friction.
- (h) Traveller – also see Rules 3(a) & 3(b)**
- i. The traveller shall be a single line. It shall be rigged as a simple closed loop through the traveller eyes and the free end passing through the traveller cleat. A splice that does not extend through the nearest traveller eye may be used at the non-free end.
 - ii. A spring, ball or tape may be used between the traveller blocks.
- 4. SAIL REGISTRATION NUMBERS, NATIONAL LETTERS AND NATIONAL FLAG**
- (For ILCA 6 and ILCA 4 sail number positions please see part 4 rule 29(e) and 30(e))**
- (a)** For boats up to sail number 148199, the sail number is a number moulded into the deck under the bow eye or into the transom, or displayed on a



plate attached to the rear of the cockpit.

For boats with sail numbers from 148200, the sail number is the number displayed on a unique World Sailing Building Plaque attached to the rear of the cockpit.

- (b) All numbers shall be in accordance with the Racing Rules of Sailing except as amended by these rules in respect of type, positioning and minimum dimensions:

Height 300 mm.

Width 200 mm (excluding digit 1).

Thickness 45 mm.

Space between adjoining numbers minimum 50 mm.

Sail numbers shall be regularly spaced.

Numbers on the starboard side shall be placed above those on the port side.

Each sail number digit shall be of one colour only.

The sail numbers shall be solid and easy to read.

After 1st March 1998 - sail numbers and national letters shall only be adhesive numbers. The use of permanent ink pens or similar to mark numbers and national letters on the sail is prohibited.

- (c) For sails with numbers above 153000 and sails purchased after 1st June 1993 the sail numbers shall be glued or sewn on each side of the sail, with the bottom of the numbers on the starboard side of the sail placed along a line parallel to and 400 mm (+ or - 12 mm) below the seam at the middle batten pocket. The bottom of the numbers on the port side of the sail shall be placed on a line 400 mm (+ or - 12 mm) below and parallel to the bottom of the numbers on the starboard side of the sail. The starboard sail numbers shall commence 100 mm (+ or - 12 mm) from the leech and the port side numbers shall end 100 mm (+ or - 12 mm) from the leech.

(For additional guidance, see the Instructions for Applying Sail Numbers on p.44 along with accompanying diagrams on pp. 45 - 49).

- (d) Sail numbers from 131000, sails purchased after 1st June 1993 and new sails stamped "New Numbers" shall have numbers that are clearly visible with the last four digits of the number in one dark, distinctive colour or black and any preceding numbers in a different, contrasting, distinctive colour (red is recommended).
- (e) Exceptions to this Rule are permitted:
- when the hull and/or sail are provided by the organisers for an event and after approval of the International Laser Class Association, the numbers on the sail used for that event only may be single, double or triple digit numbers.
 - in the case of a boat borrowed or chartered for a specific event, and after written approval from the Race Committee, a competitor may use a sail with numbers that are different to the sail number allocated to the hull. The sail number used shall be the sail number allocated to the competitor's own boat. When the competitor does not own a boat, the number used on the sail shall be the number of the boat chartered.
 - when a sail is damaged during a series and Rule 7 (c) applies the sail number may contravene Rules 4 (a) and (e) ii only when written permission for a sail number change is given by the Race Committee.
- (f) **National Letters**, if required, shall conform to the same type, size, spacing and requirements as sail numbers (refer rule 4(b), (c), (d) and (e)) and shall be positioned as follows:

The letters on the starboard side of the *MKI* sail shall be placed along the top edge of the seam below the bottom batten pocket (+ or - 12mm), for the *MKII* sail on a Base Line 400mm (+ or - 12mm) below the bottom batten pocket and on the port side of the sail along a line 400 mm (+ or - 12mm) below and parallel to the letters on the starboard side. The starboard letters shall commence 100 mm (+ or - 12 mm) from the leech and the port letters shall finish 100 mm (+ or - 12 mm) from the leech. The letters shall all be the same colour, which may be one of the colours of the digits of the sail number, or another distinctive colour [also see diagrams on pages 45-49].

National Letters shall be required at all World Championships, Regional Championships and events described as international events in the notice of race or sailing instructions. National Letters may be required at any other regatta by the notice of race or sailing instructions.

(g) RED RHOMBUS

- Sails used in the following women's events shall carry a red rhombus above the top batten pocket on both sides;
 - World or regional (continental) championships.
 - Events described as "international events" by the Notice of Race or Sailing Instructions.
 - Other events that prescribe in the Notice of Race or Sailing Instructions that women competitors should be identified.
- The minimum size and approximate position shall comply with diagram on page 32.
- The rhombus may be retained for racing in other events.

(h) NATIONAL FLAG

If required by the Notice of Race and the Sailing Instructions, a national flag with a nominal size of 567 x 337 mm shall be applied to both sides of the mainsail. For the ILCA 7 and ILCA 6 sails, flags shall be positioned such that the aft edge of the flag is within 100 and 150 mm of the leech and between the sail numbers and the batten pocket below the sail numbers. The flag shall be approximately parallel with the sail numbers and letters and shall not touch the numbers. For the ILCA 4 sail, the flag shall be positioned within 100 and 150 mm of the leech but below and within 50 mm of the bottom batten pocket. The flag shall be printed on separate material applied to the sail. The use of permanent ink pens or similar to make a national flag is forbidden. The national flag shall correspond to the national letters.

5. MAST

No mast which has a permanent bend shall be used at any time.

6. CLOTHING AND EQUIPMENT

- For the purposes of RRS 50.1 (b) the maximum total weight of competitors' clothing and equipment shall be 9kg (for ILCA 6 and ILCA 4 rigs please see part 4).
- Competitors shall not wear or carry non floating clothing or equipment which in total weight exceeds 500 grammes dead weight except protective sailing clothing.
- For the purposes of weighing clothing and equipment as required by RRS Appendix H three coat hangers may be used instead of a rack.

7. SAILING REQUIREMENTS

- The boat shall be raced with either one or two persons aboard.

When two persons race a boat they shall race together throughout the entire race or series of races without alternating at the helm.

- (b) No part of the helmsman or crew may be placed forward of the mast while racing.

(c) Sails

In a series of races a sail shall not be changed for another unless written permission for an individual change is obtained from the race committee. Written permission shall only be given in the event of a sail damaged beyond repair or damaged to the extent that it cannot be repaired before the start of the next race in a series. In the event of a change the damaged sail shall not be used again in that series even if it is subsequently repaired.

For the purpose of this rule, a series is deemed to be two or more individual races which count towards an overall points total.

8. HULL COATINGS

The use of slowly soluble applications which might alter the boundary layer characteristics of the hull are prohibited.

9. CLASS ASSOCIATION MEMBERSHIP

No person is permitted to race in any Fleet, interFleet, District, or other sanctioned event unless at least one member of the crew is a current member of the International Laser Class Association (a member of a District ILCA Association duly established in accordance with the Constitution is a member of the International Laser Class Association).

10. ADVERTISING

Advertising, including competitor advertising, is permitted in accordance with World Sailing Regulation 20 - Advertising code; except that the sail window shall be kept free of advertising or other graphic material.

PART THREE

OPTIONS & EXCEPTIONS

TO PARTS ONE & TWO

11. HULL FINISH

- (a) Waxing, polishing and fine wet and dry sanding of the hull is permitted, provided the intention and effect is to polish the hull only. Polishing/sanding shall not be used to remove mould imperfections.
- (b) Sanding and refinishing of the hull with the intention or effect to lighten the hull or improve the performance, finish, materials or shape beyond the original is not permitted.

12. TRANSOM DRAIN BUNG

A retaining line may be attached to the transom drain bung and the gudgeon.

13. SELF BAILER

A self-bailing device as supplied only by the builder may be added. The bailer may be sealed with tape, filler or glue along its edge where it joins the hull and at the screw hole. Filling the screw hole level with the flat surface of the bailer is permitted. Fairing the flat surface of the bailer to the hull shape or changing the profile of the bailer is not permitted. The drain bung may be removed from the self-bailer, and the self bailer opening pin may be secured to the cockpit floor with self adhesive plastic tape. The builder-supplied o-rings may be substituted with non builder-supplied alternatives provided the basic function of the bailer is unchanged.

14. CENTREBOARD

- (a) A rope handle passing through not more than two holes of maximum diameter 12.5 mm above a line

drawn from the bottom of the centreboard stop, parallel to the top of the centreboard is permitted. A plastic/rubber tube and/or tape are permitted on the handle of the centreboard.

- (b) The trailing edge of the centreboard may be sharpened by sanding the blade between the trailing edge and a line 100 mm parallel to the trailing edge, provided the distance between the leading edge and the trailing edge of the blade is not reduced.
- (c) Surface refinishing of the centreboard is permitted provided the original shape, thickness and characteristics are not altered.
- (d) One layer of any material of maximum 2mm thickness and of a maximum size of 30mm x 30mm may be applied at the top front corner of the centreboard case. Vertical cuts are allowed in the material to allow the material to conform to the shape of the centreboard case.
- (e) A wood centreboard shall not be used on a hull that was originally supplied with a non wood centreboard.
- (f) A tie line or shock cord shall be attached to the small hole in the upper forward corner of the centreboard, and any of the bow eye, the cunningham fairlead, the "Builder Supplied" deck block fitting and the mast to prevent loss of the centreboard in event of a capsized. The tie line or shock cord may be looped around the bow, but shall not be attached to the gunwale. Attachment can be by knots or loops in the shock cord, and/or tie lines, shackles, clips, hooks or eyes. When the shock cord is attached to the bow eye it may also pass through an attachment to the "Builder Supplied" deck block fitting or the cunningham fairlead.
- (g) The components of the "Builder Supplied" centreboard stopper may be secured together by glue, screws, bolts, nuts and washers, provided the original shape and dimensions are not reduced.

15. RUDDER

- (a) The trailing edge of the rudder blade may be sharpened by sanding the blade between the trailing edge and a line 60 mm parallel to the trailing edge, provided the distance between the leading edge and the trailing edge of the blade is not reduced.
- (b) Surface refinishing of the rudder blade is permitted provided that the original shape, thickness and characteristics are not altered.
- (c) The rudder blade and/or rudder head holes may be enlarged up to a maximum diameter of 10mm. The rudder bolt and bush set may be replaced with a larger diameter bolt to fit this hole. The bolt head, nut and washers shall fall within a 20mm diameter circle.
- (d) To achieve the maximum 78 degree rudder angle relative to the bottom edge of the rudder head, the leading edge of the blade may be cut away where it touches the spacing pin.
- (e) To restrict the rudder angle to maximum 78 degrees relative to the bottom edge of the rudder head, the lower forward spacing pin may be wound with flexible adhesive tape.
- (f) The rudder pintles may be fitted with spacers to lift the rudder head to allow the tiller to clear the deck at the transom.
- (g) The rudder downhaul line may have multiple purchases.
- (h) A hole may be drilled in the top rudder pintle and a pin or clip inserted in the hole to prevent loss of the rudder.

- (i) A wood rudder shall not be used on a hull that was originally supplied with a non wood rudder.
- (j) The rudder shall be maintained in the full down position except whilst racing in water less than 1.5m deep unless otherwise specified in the sailing instructions.
- (k) Padding of uniform thickness may be used in the gap between the rudder blade and rudder head. This padding must cover completely the part of the rudder blade that comes in contact with the rudder head. The thickness of the rudder blade plus the padding must not exceed 20.3mm.

16. TILLER

- (a) The tiller and tiller extension are not restricted in any way except that the tiller:
 - i. shall be capable of being removed from the rudder head.
 - ii. shall be fitted with a cleat, hook, pin or eye to secure the downhaul.
 - iii. shall, except for normal wear caused by the traveller rope, be straight along its topmost edge between a point 30 mm in front of the forward edge of the rudder head and the cockpit end of the tiller.
- (b) The tiller may be fitted with an "anti wear" strip or tube of not more than 200 mm in length placed above the level of the straight edge required by 16 (a) iii and only where the traveller crosses the tiller.
- (c) The use of a tiller retaining pin is optional.

17. HIKING STRAP

- (a) The hiking strap may be substituted with any type of non-stretch material and it may be padded.
- (b) The hiking strap may be fixed to the cockpit at the forward end by wrapping the strap around the mainsheet block plastic pressure plate or by using both the centreboard friction attachment plate and the mainsheet block friction pressure plate.
- (c) The hiking strap supporting line between the aft end of the hiking strap and the eye straps on the aft face of the cockpit may be rigged in any manner so that the hiking strap is fixed or adjustable and may include one cleat; one ring, thimble, or shackle; or both.
- (d) A shock cord may be attached between the aft end of the hiking strap and to either the traveller cleat, or the hiking strap eye straps at the aft end of the cockpit.

18. BOOM

- (a) A metal sleeve supplied by the builder of maximum length 900 mm may be fixed inside the boom. The sleeve shall not extend aft of the point 1220 mm from the front end of the boom (including plug).
- (b) The stainless steel mainsheet eye strap between the two blocks on the boom may be replaced with a soft strap. The maximum width of the soft strap shall be 26mm. The soft strap shall only be fixed to the boom using the holes drilled by the builder as shown in the diagram below.
- (c) Traveller and Boom mounted mainsheet blocks may be replaced with the "Builder Supplied" blocks shown in the photo.



19. MAST

- (a) To prevent abrasion of the mast step, tubes or collars of uniform thickness not exceeding 1 mm in total may be placed around the entire circumference of the lower mast or the mast step cavity. A tube or collar shall not extend more than 10 mm above deck level. In addition, a disc of uniform thickness not exceeding 1mm in thickness may be placed in the bottom of the mast step.



- (b) The mast or mast cavity may be lubricated.
- (c) Tape or other bushing material may be applied to both the plastic end cap, the collar of the upper mast and the upper mast to ensure a snug fit. The tape or bushing material may only be used on that portion of the plastic parts that actually slide into the lower section and/or between the upper mast and the collar and it shall be a uniform thickness around the circumference. Taping or bushing material above the collar to fair the collar into the mast is prohibited.
- (d) Flexible adhesive tape may be applied to the outside of the joint of the upper and lower mast sections to a limit of 40mm above and below the joint to prevent rotation of the mast sections at the joint.

CROSS SECTIONS THROUGH BOOMS AND SOFT STRAPS SHOWING THE ONLY LEGAL FIXING OPTIONS

Diagram for Rule 18(b)

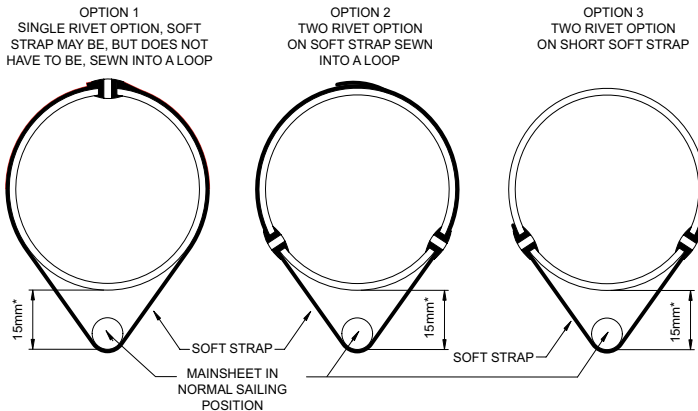

NOTES:
 1. 15mm DIMENSION MARKED * IS NOMINAL
 2. HOLES FOR OPTIONS 2 AND 3 ARE POSITIONED TO FIT THE ORIGINAL STAINLESS STEEL EYE STRAP
 3. NO BOOM SHALL BE DRILLED WITH THREE HOLES AT THE BOOM STRAP POSITION

20. INSPECTION PORTS

Inspection ports not exceeding 153 mm internal diameter may be installed on the deck or in the cockpit to provide access to the hull cavity, provided that any inspection port is fitted with watertight threaded covers (any bayonet mounted parts are deemed to be not threaded).

Storage receptacles are permitted underneath hatch covers.

21. CLIPS AND STORAGE BAGS

Clips, ties or bags to stow or secure safety or other equipment may be used on the deck, in the cockpit, around the mast or boom.

22. COMPASS, ELECTRONIC EQUIPMENT AND TIMING DEVICES

- (a) One compass mounted on any part of the deck or the cockpit is permitted if the hull cavity is not pierced by anything other than the fasteners. Compasses may not be fitted to inspection ports. An additional wrist mounted compass is permitted. Electronic, self-contained, digital compasses using only magnetic input are permitted.
- (b) Timing devices are permitted.
- (c) A timing device and electronic compass may be integrated in the same device.
- (d) A compass or timing device must not be capable of displaying, delivering, transmitting, receiving, calculating, correlating or storing information about wind speed, wind direction, boat speed or boat position.
- (e) Any use of electronic equipment not specifically allowed in the rules is prohibited unless the rules are modified by the sailing instructions.

23. WIND INDICATORS

- (a) Wind indicators may be attached as desired provided the sail is not cut and the buoyancy qualities of the hull and mast are not impaired.
- (b) Ribbons, wool or similar wind indicators may be attached to the sail.

24. TAPE AND LINE

The use of flexible adhesive tape or similar, line or heat shrink tube is permitted to secure shackle pins and clips, and to bind sheets, control lines and rigging, except that tape or line shall not be used to construct new fittings or modify the function of existing fittings.

25. SAFETY EQUIPMENT

Any additional equipment required by an international, national or other governing authority for safety purposes may be fitted or carried provided it is not used in contravention of the FUNDAMENTAL RULE.

26. REPAIRS AND MAINTENANCE

- (a) Repairs and preventative maintenance to the sail, hull, deck, centreboard, rudder, mast, boom or any fittings and fixings may be carried out without violation of these Rules provided such repairs are made in such a way that the essential shape, characteristics or function of the original are not affected.
- (b) In the event of the failure of any fittings, or the replacement of fittings as authorised by these Rules, the fitting or the replacement shall be the same type as the original and shall be placed in a position conforming to the Measurement Diagrams.
- (c) Preventative maintenance includes the replacement of fasteners (screws, bolts, nuts, washers and rivets) provided the replacement does not alter the function of the fitting. The tolerances of the Measurement Diagrams shall not be used to alter the position of fittings. In addition the reversing of spars is permitted

if the fittings are replaced in accordance with the Measurement Diagrams. Any holes in the top section of the mast shall be permanently sealed with a rivet or similar to maintain the buoyancy of the mast. .

- (d) Sail panels and luff sleeves shall not be replaced.
- (e) Any flotation equipment (flotation foam blocks or Cubitainer inserts) that is defective or has been removed shall be replaced by fully air filled, builder supplied, Cubitainer inserts which shall have an equal volume to the defective or removed flotation equipment.
- (f) The use of lubricants is unrestricted except that they shall not be used on the hull (below the gunwales).

27. REEFING

The sail may be reefed by rolling the sail around the mast 1 or 2 times.

28. BOAT OR BODY MOUNTED CAMERA

One camera may be attached to the sailor or may be mounted on the boat if the hull cavity is not pierced by anything other than the fasteners.

PART FOUR ILCA 6 RIG AND ILCA 4 RIG OPTIONS

Part 4 of these rules shall be read in conjunction with the remainder of the Class Rules.

When the ILCA 6 or the ILCA 4 rigs are used the Rules of Parts 1, 2, 3 and 5 of the ILCA Class Rules apply except where specifically amended by Part Four.

29. ILCA 6 RIG

- (a) The ILCA 6 sail and bottom mast as supplied by an approved Builder shall conform to the measurement diagrams which form part of these Rules.
- (b) The ILCA 6 rig may be used in any class regatta subject to the conditions in 29 (c) and any restrictions in the Notice of Race and Sailing Instructions.
- (c) The ILCA 6 rig may only be used in District Championships and higher level regattas when prescribed in the Notice of Race and Sailing Instructions.
- (d) In a series of races a ILCA 6 rig shall not be changed for a ILCA 7 or ILCA 4 rig. A series is 2 or more races that count towards an overall points total.
- (e) SAIL REGISTRATION NUMBERS & NATIONAL LETTERS

Rules 4(c) and (f) shall be amended to read as follows:

- 4(c) For ILCA 6 sails with numbers above 153000 and sails purchased after 1st June 1993 the sail numbers shall be glued or sewn on each side of the sail, with the bottom of the numbers on the starboard side of the sail placed along a line parallel to and 400 mm (+ or - 12 mm) below the underside of the middle batten pocket. The bottom of the numbers on the port side of the sail shall be placed on a line 400 mm (+ or - 12 mm) below and parallel to the bottom of the numbers on the starboard side of the sail. The starboard sail numbers shall commence 100 mm (+ or - 12 mm) from the leech and the port side numbers shall finish 100 mm (+ or - 12 mm) from the leech.

(For additional guidance, see the Instructions for Applying Sail Numbers on p. 44 along with accompanying diagrams on pp. 45 - 49).

- 4(f) **National Letters**, if required, shall conform to the same type, size, spacing and requirements as sail numbers (refer rule 4(b), (c), (d) and (e)) and shall be

positioned as follows (also see diagram):

The top of the letters on the starboard side of the sail shall be placed on the bottom edge of the bottom batten pocket and its extension (+ 12 mm). The starboard letters shall commence 100 mm (+ or - 12 mm) from the leech. The bottom of the letters on the port side shall be placed on a line 400 mm (+ or - 12 mm) below and parallel to the bottom of the letters on the starboard side of the sail. The port letters shall finish 100 mm (+ or - 12 mm) from the leech. The letters shall all be the same colour, which may be one of the colours of the digits of the sail number, or another distinctive colour.

National Letters shall be required at all World Championships, Regional Championships and events described as international events in the notice of race or sailing instructions. National Letters may be required at any other regatta by the notice of race or sailing instructions.

(f) CLOTHING AND EQUIPMENT

Rule 6(a) shall be amended to read as follows:

6(a) For the purposes of RRS 50.1 (b) the maximum total weight of competitors clothing and equipment shall be 9 kg.

30. ILCA 4 RIG

(a) The ILCA 4 sail and bottom mast as supplied by an approved Builder shall conform to the measurement diagrams which form part of these Rules.

(b) The ILCA 4 rig may be used in any class regatta subject to the conditions in 30 (c) and any restrictions in the Notice of Race and Sailing Instructions.

(c) The ILCA 4 rig may only be used in District Championships and higher level regattas when prescribed in the Notice of Race and Sailing Instructions.

(d) In a series of races an ILCA 4 rig shall not be changed for a ILCA 7 or ILCA 6 rig. A series is 2 or more races that count towards an overall points total.

(e) SAIL REGISTRATION NUMBERS

Rules 4(b), 4(c) and 4(f) shall be amended to read as follows:

4(b) On ILCA 4 sails all numbers shall be in accordance with the Racing Rules of Sailing and shall be of the following minimum dimensions:

Height 220 mm.

Width 150 mm excluding digit 1.

Thickness 30 mm.

Note: Optimist Class legal numbers conform to this rule.

The maximum height to conform is 240mm.

Space between adjoining numbers / letters and rows minimum 30 mm.

Sail numbers shall be regularly spaced.

Numbers on the starboard side shall be placed above those on the port side.

Each number digit shall be one colour only.

The numbers shall be solid and easy to read.

4(c) For ILCA 4 sails with numbers above 153000 and sails purchased after 1st June 1993 the sail numbers shall be glued or sewn on each side of the sail, with the bottom of the starboard numbers placed along the top edge of a line placed 270mm (0 to +12mm) below and parallel to the seam below the bottom edge of the middle batten pocket. The port side numbers shall be placed along a line 270mm below and parallel to the bottom of

the starboard side numbers. The starboard side numbers shall commence 100 mm (+ or - 12 mm) from the leech and the port side numbers shall end 100 mm (+ or - 12 mm) from the leech.

(For additional guidance, see the Instructions for Applying Sail Numbers on p. 44 along with accompanying diagrams on pp. 45 - 49).

4(f) National letters, if required, shall conform to the same type, size, spacing and requirements as ILCA 4 numbers (refer rule 29 (e) 4 (b)).

For all ILCA 4 sails with numbers from 190000, and for sails purchased from 1 April 2006 onwards, The bottom of the starboard side letters shall be placed along a line 270mm (+12mm) below and parallel to the bottom of the numbers on the port side and start 100mm (+ or -12mm) from the leech. The bottom of the letters on the port side shall be placed along a line 270mm (+12mm) below and parallel to the bottom of the letters on the starboard side and finish 100mm (+ or -12mm) from the leech.

For ILCA 4 sails with numbers under 190000 that were purchased before 1 April 2006, they may be placed as above or along the same line, 270mm below and parallel to the bottom of the numbers on the port side, on opposite sides of the sail. The letters on the port side shall be closer to the leech than those on the starboard side, with the port side letters finishing 100mm (+ or - 12mm) from the leech.

National Letters shall be required at all World Championships, Regional Championships and events described as international events in the notice of race or sailing instructions. National Letters may be required at any other regatta by the notice of race or sailing instructions.

The letters shall all be the same colour, which may be one of the colours of the digits of the sail number, or another distinctive colour.

(f) MAST

Rule 5 shall be amended to read as follows:

5 The ILCA 4 bottom mast is supplied with a pre-bend aft of approximately 5 degrees. The pre-bend shall not be increased or decreased. No top mast that has permanent bend in it shall be used at any time.

(g) CLOTHING AND EQUIPMENT

Rule 6(a) shall be amended to read as follows:

6(a) For the purposes of RRS 50.1 (b) the maximum total weight of competitors clothing and equipment shall be 8 kg.

PART FIVE

31. AMENDMENTS

Amendments to these Rules shall be approved by each of:

- (a)** the World Council,
- (b)** at least two-thirds of the membership casting a vote in response to a ballot published by the International Office of the Class. Only those votes submitted within one month from the date of publication of the rule change ballot shall be valid, and
- (c)** World Sailing.

Class Rule Interpretations

1. Approved compasses that meet the requirements of Rule 22. Compass, Electronic Equipment and Timing Devices.
A list of approved compasses can be found on the ILCA website - please go to the "Interpretations" tab under "ILCA Class Rules".
2. Repairs and Maintenance: Sailors may apply anti-abrasion material at the traveller fairleads to prevent wear of the deck as a form of preventative maintenance under rule 26(a).
3. Hiking Strap: A sheaveless block, such as the "shock block" or equivalent, will be considered a ring for the purpose of rule 17(c).
4. In accordance with ILCA Class Rule 22e, the use of heart rate monitor with no additional function or capability is permitted. The heart rate monitor device shall comply with Class Rule 22.

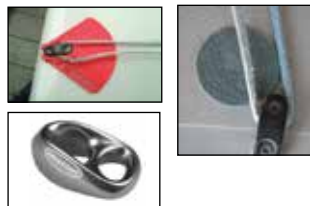

Instructions for Applying Red Rhombus For Women's Events

Sails used in the following women's events shall carry a red rhombus above the top batten pocket on both sides;

- a. World or regional (continental) championships.
- b. Events described as "international events" by the Notice of Race or Sailing Instructions.
- c. Other events that prescribe in the Notice of Race or Sailing Instructions that women competitors should be identified.

The minimum size and approximate position shall comply with diagrams below.

The rhombus may be retained for racing in other events.

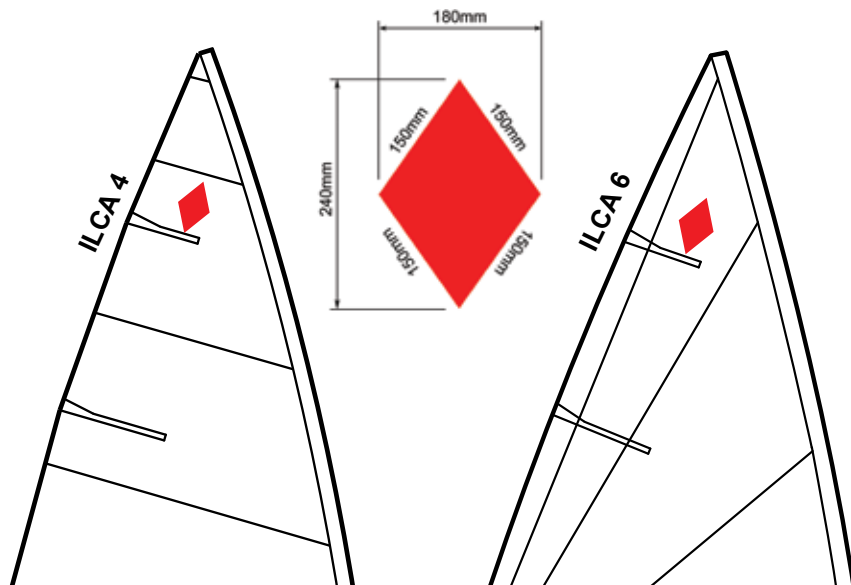

ILCA 7, ILCA 6 & ILCA 4 MAST TOP SECTION

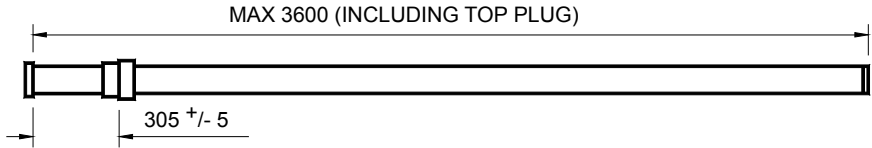

ILCA 7, ILCA 6 & ILCA 4 BOOM

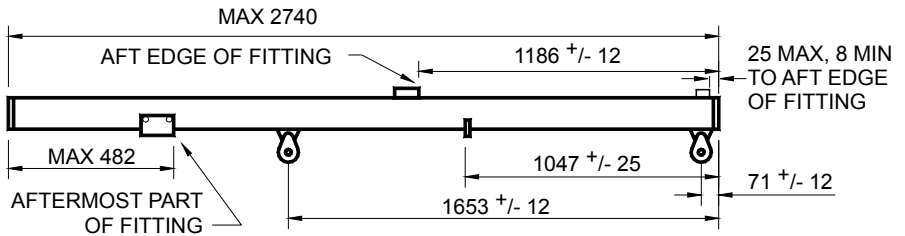

All dimensions shown
in millimetres
(not to scale)

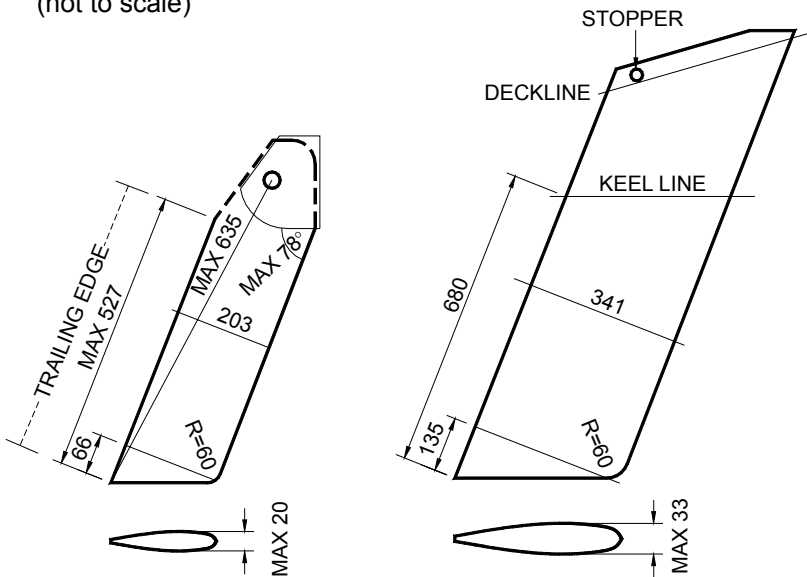

ILCA 7 CLASS MKI SAIL & MAST BOTTOM SECTION

All dimensions shown in millimetres (not to scale)

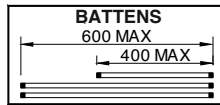
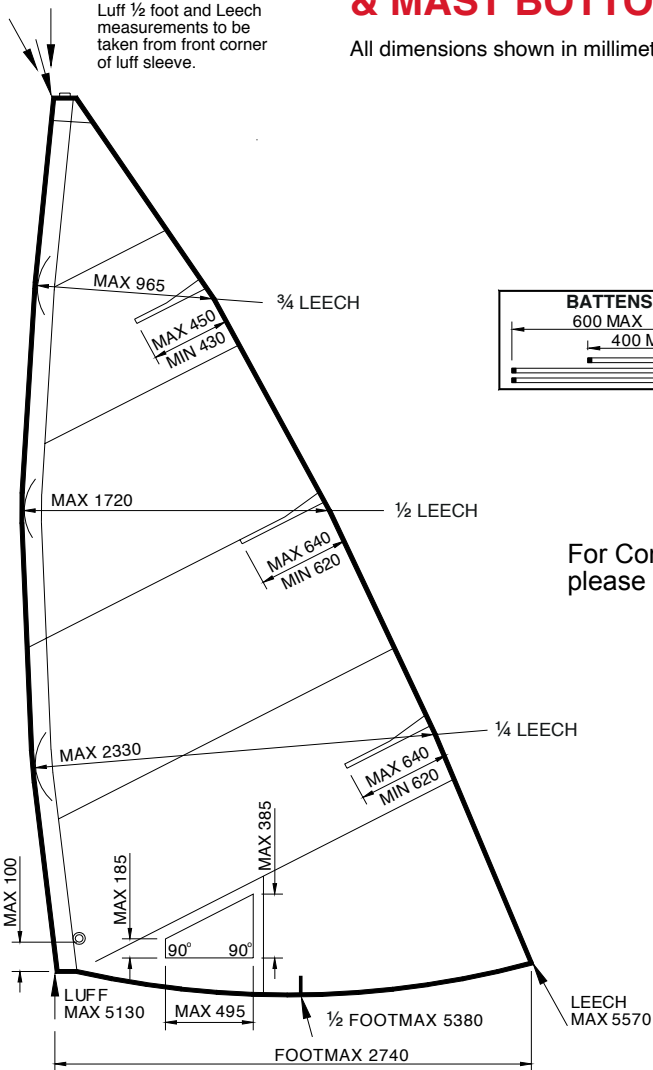

For Concave Batten Caps please see page 40

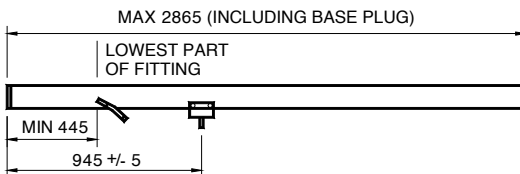

ILCA 7 CLASS MKII SAIL & MAST BOTTOM SECTION

All dimensions shown in millimetres (not to scale)

UPDATED SEPTEMBER 2025

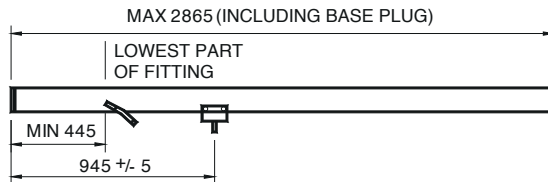
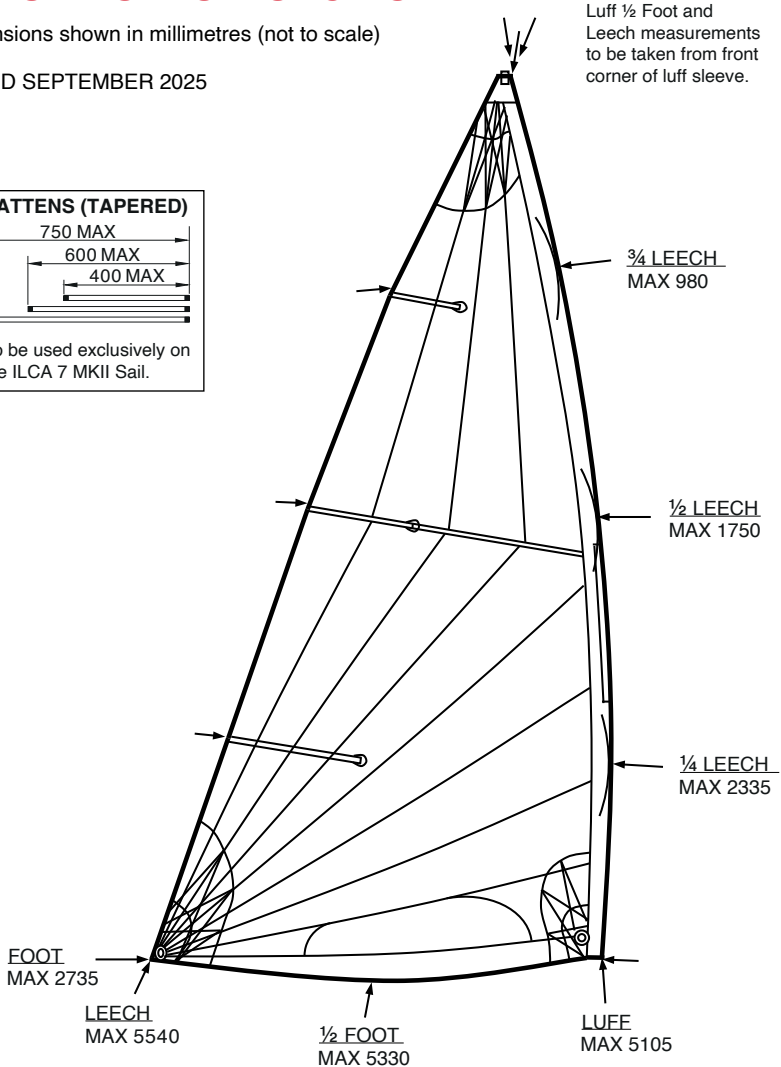
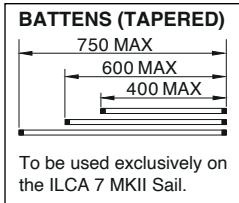

ILCA 6 CLASS SAIL & MAST BOTTOM SECTION

All dimensions shown in millimetres (not to scale)

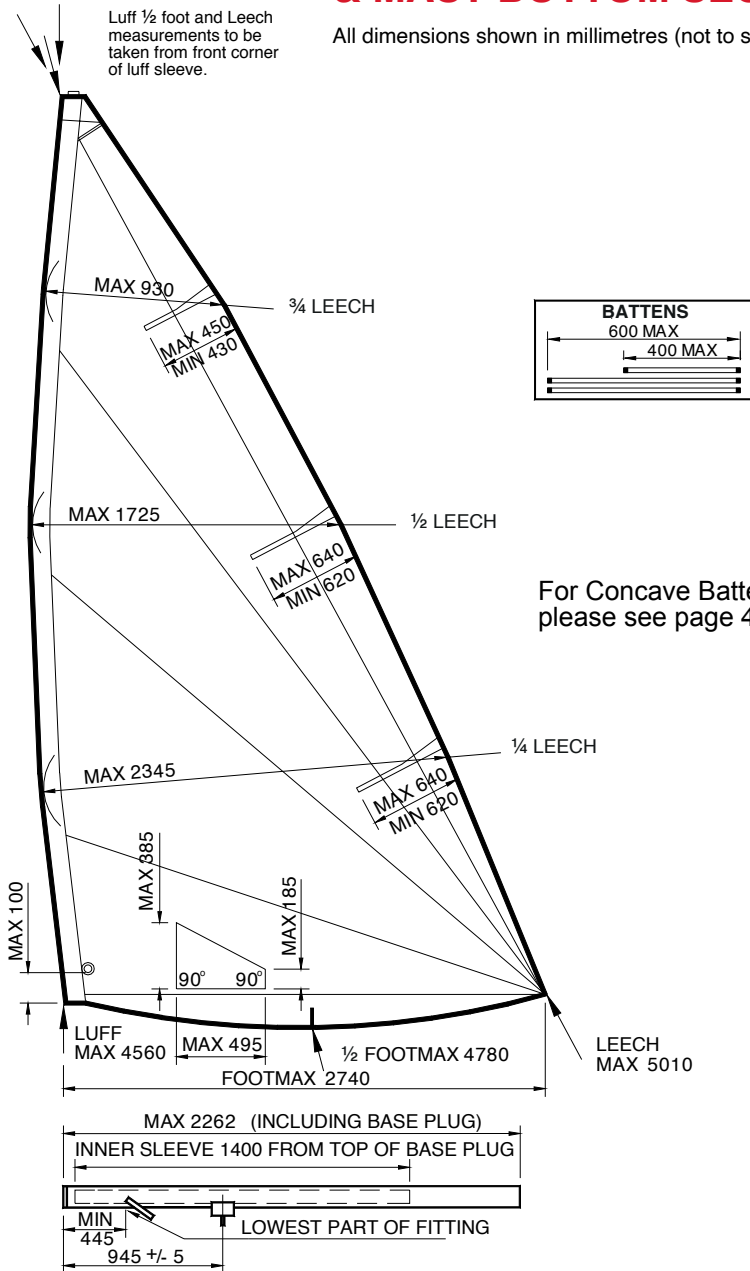

ILCA 4 CLASS SAIL & MAST BOTTOM SECTION

All dimensions shown in millimetres (not to scale)

UPDATED AUGUST 2017

Luff and Leech measurements to be taken from front corner of luff sleeve.

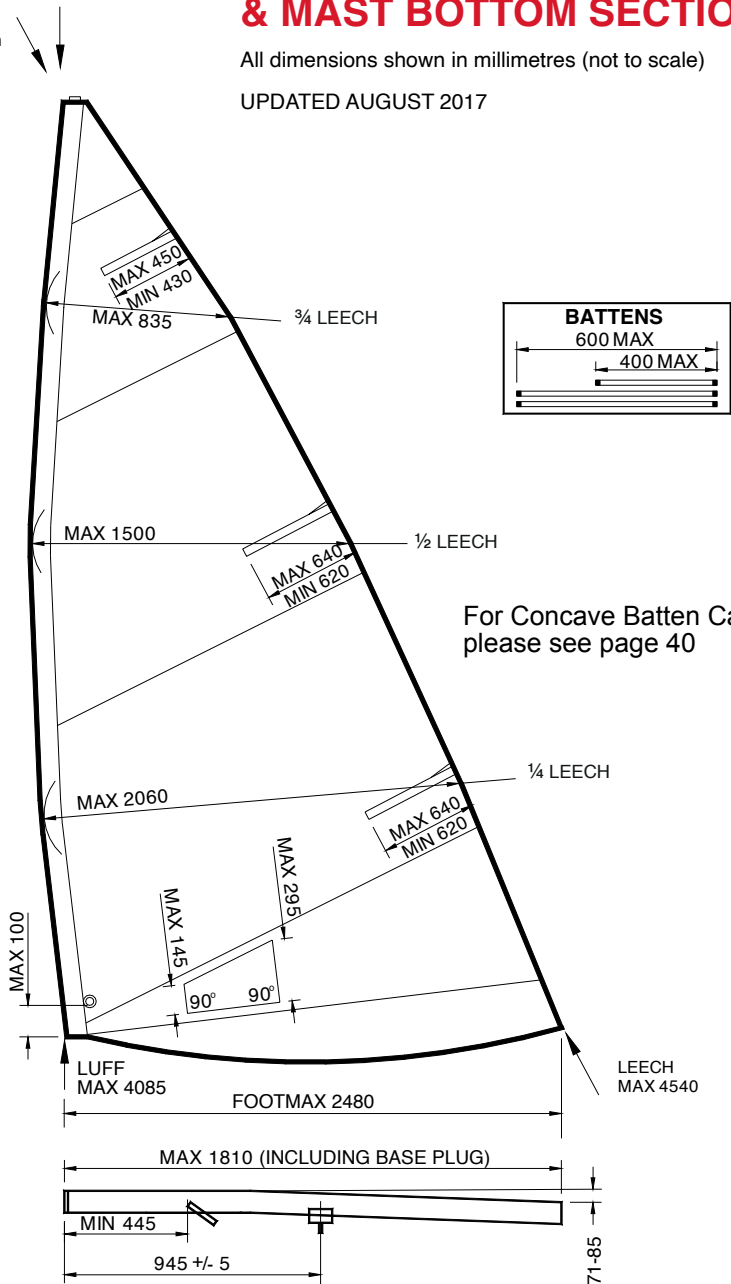

ILCA 4 CLASS MKII SAIL & MAST BOTTOM SECTION

All dimensions shown in millimetres (not to scale)

UPDATED FEBRUARY 2026

Luff ½ Foot and
Leech measurements
to be taken from front
corner of luff sleeve.

BATTENS (TAPERED)

600 MAX
350 MAX

To be used exclusively on
the ILCA 4 MKII Sail.

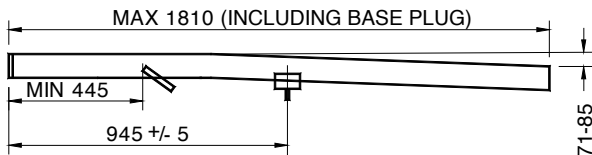
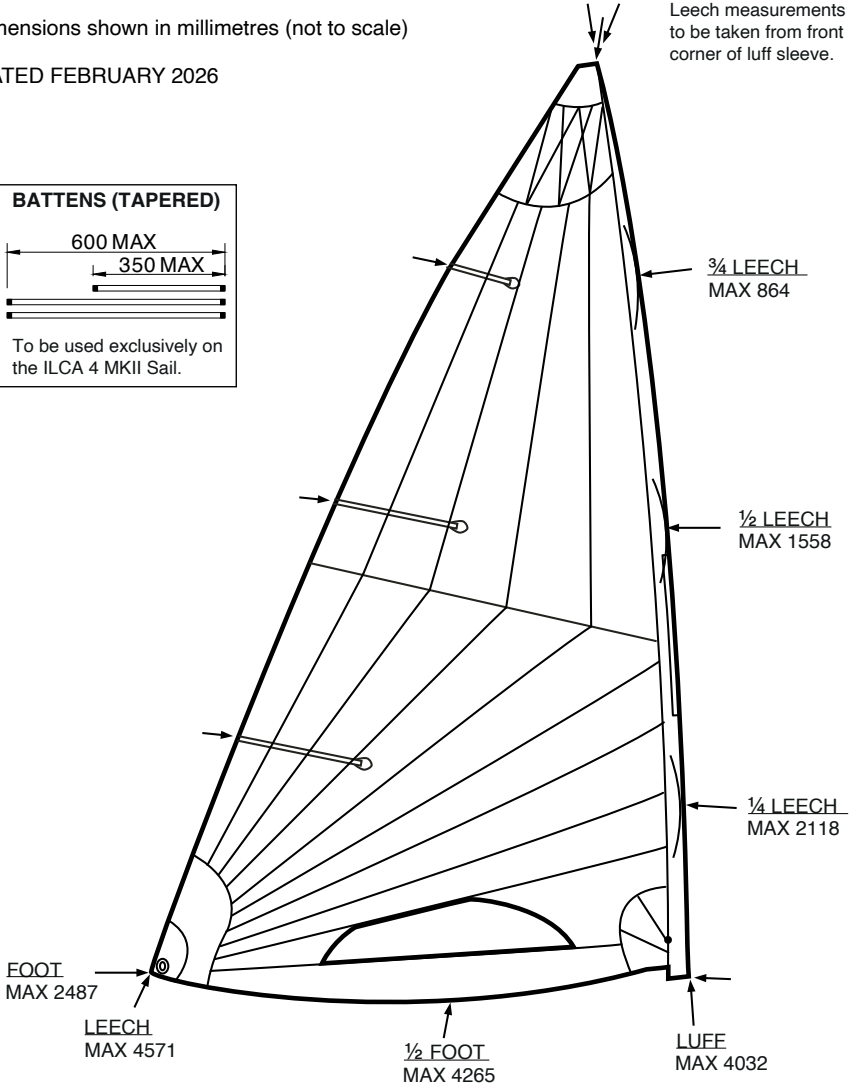

Concave Batten Caps

For ILCA 4, ILCA 6 and ILCA 7 MKI (Cross Cut) Sails
Not applicable for ILCA 7 MKII Sails

The diagrams below illustrate the methods to be used for the measurement of battens using both classic and concave end caps. Please see pages 35-39 for full sail and bottom section diagrams.

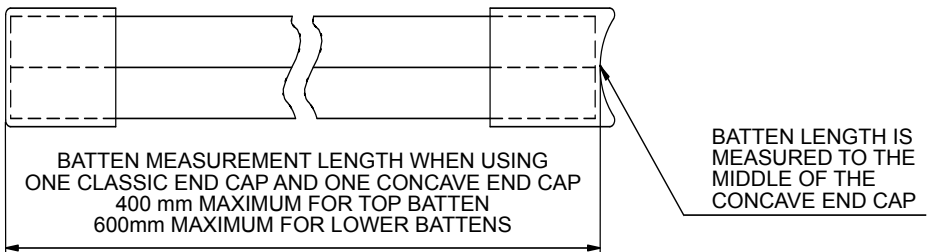
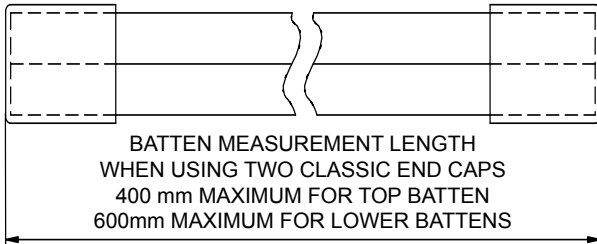

ILCA ByLaws

For information on all the ILCA ByLaws, please go to our website at: www.ilcasailing.org

ILCA Measurement ByLaw

- If a protest is lodged against a boat alleging that there has been an alteration or addition thereto not permitted by the Rules of the Class, and the Technical Committee, on investigation, is in doubt as to whether a violation of the Rules has occurred, it shall measure the part of the boat subject to protest in accordance with paragraph 2.
- (a) **Hull**

The part of the hull of the boat subject to protest shall be measured in accordance with the measurement directions attached as Schedule A and the same part of not less than five (5) other boats, chosen by the Technical Committee as random samples, shall be measured in the same manner. The Technical Committee shall select, if possible, boats which show no evidence of having been repaired or altered and which do not have inspection ports.

The arithmetic mean of the measurements of the boats chosen as the sample shall be calculated, and the protested boat shall be disqualified if the difference between the mean value so determined and the measurement on the boat subject to protest shall exceed the following values for the measurements indicated:

| | |
|---|------|
| any point along the keel line (rocker): | 2 mm |
| any other area of the hull: | 3 mm |

(b) Equipment

If any mast, boom, fitting, centreboard or rudder is the subject of a protest as to size, shape or location, measurement thereof shall be governed by the drawings and tolerances set forth in the Measurement Diagrams of the ILCA Class Rules.

- This Bylaw shall be read and construed in conjunction with the ILCA Class Rules and the Interpretations of the ILCA Chief Measurer, and may be amended by the World Council.

Schedule A to ILCA Measurement Bylaw

1. Measurement Template

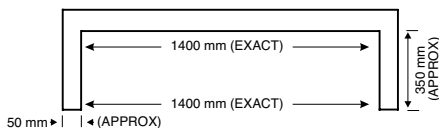

2. Measurement of Hull

Turn boat upside down. Starting at the transom, measure out a distance along the keel line and establish point A, which will fall roughly athwartships of point X, the area under protest.

Lay a straight edge across the transom as shown in the sketch and measure out a distance along the vertical surface of the gunwale and establish point B, which will fall approximately in line with the measured point on the keel line (A) and the area under protest (X). Distances shown are as an example only.

The centre line of the boat must then be established at point A. This will be easy in the front one third of the boat but, to find the centre line in the aft two thirds, stretch a string over the centre of the centreboard opening and the centre of the bailer depression and extend fore and aft, as necessary. Mark the centre line at point A. Now measure from point A to point X and retain this figure to establish an equal point of measurement on the five random sample boats.

Place the centre of the measurement template on point A (Diagram 2), line up the vertical arms with points B and equalise exactly the distance from the horizontal bar to the inside of the gunwale on each side of the boat.

Measure the shortest distance from point X up to the horizontal bar and record this measurement (96 mm in example).

This procedure should now be repeated using all the distances established above and a similar reading obtained for the distances from the hull to the horizontal cross bar on the other five sample boats.

Example: Measurements on 5 sample boats:

| | |
|-------------------------------|--------|
| 93 + 94 + 94 + 97 + 96 | = 474 |
| Arithmetic mean = 474/5 | = 94.8 |
| Measurement on protested boat | = 96 |
| Difference | = 1.2 |

Diagram 1

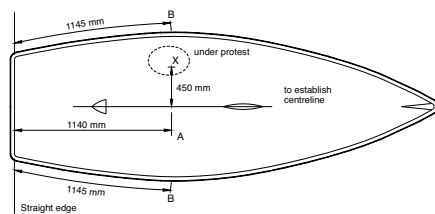
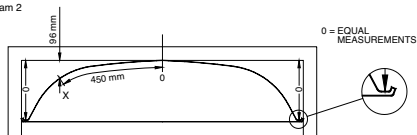

Diagram 2



This does not exceed mean value by more than 3 mm, therefore protest is disallowed.

Measurement of Rocker

Turn boat upside down. Measure out a distance of 3430 mm along the keel line of the boat.

Set up a taut string over the centre line of the boat exactly 125 mm above the keel at the transom and 85 mm above the keel at 3430 mm from the transom.

Measure distance along keel to point under protest (point X) and retain this figure to establish an equal point of measurement on the five sample boats.

Measure the shortest point from point X to the string and then repeat procedure with five sample boats.

Calculate arithmetic mean of the measurements from the five sample boats. Point under protest should not deviate by more than 2 mm.

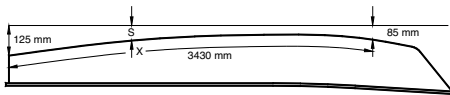

Technical Tips

One of the great things about the ILCA is it is instant sailing. It takes only a few minutes to rig and then you are out on the water. Here are some ideas to help make rigging and sailing even more simple.

How to change the hiking strap

The hiking strap connection to the front end of the cockpit is one of the most critical screwed joints in the boat. After all there is nothing worse than jumping out onto the new tack, in the heat of a race, and ending up head first in the drink!

So when changing a hiking strap here are some tips on how to avoid potential failures through stripped threads, broken screws or leaks:-

1. Do not use a power drill or power screwdriver – it is too easy to strip threads or misalign the screws.
2. Use a normal hand screwdriver.
3. When undoing the screws walk them out a turn or two at a time, first one, then the other.
4. When replacing the screws seal the threads with a silicone or polyurethane sealer and walk them in, a turn at a time, first one then the other.
5. When finally seating the screws be careful not to over torque. It is important to firmly torque with a hand screwdriver but that is sufficient.



When chartering a boat at a regatta please refer to the charter boat operator's policy on changing hiking straps.

Mast retention line (class rule 3(b) xi.)

The mast retention line is one of the most important lines on the boat. It must allow 180 degree rotation of the mast and at the same time keep the mast in the deck tube in the event of a capsize. It is important that the mast cannot move in and out of the tube by more than 50mm. A mast retention line with too much movement may result in the mast sliding most of the way out of the tube and then breaking through the side of the tube and the deck when the boat is righted after a capsize.

You will need 640mm of 5mm diameter line and a 15mm plastic stop ball. Core spectra line works well as it is low friction.

1. Tie a stop knot in one end of the line and thread the stop ball on to the line.
2. Pass the loop through the 2 eyes on the deck block plate (fig 1).
3. Tie a bowline in the other end of the line so that the overall length of the line from the end of the loop to ball is 570mm. The loop of the bowline should be just big enough to allow the stop ball to pass through the loop.
4. Take the loop end round the front of the mast and then behind the mast over the top of the mast boom vang attachment point and back to the front of the mast.
5. Take the ball end of the rope to the front of the mast and pass through the loop to secure (fig 2).



fig 1



fig 2

The retention line can be left on the boat through the deck block fitting so it does not get lost.

Is Your Rudder Angle Correct?

The rudder angle is measured between the bottom edge of the rudder box and the front edge of the rudder blade. If the front edge of the rudder exceeds 78 degrees, it is more vertical than it should be. During equipment inspection, this is measured using a standard gauge manufactured to quickly determine whether the angle conforms to the 78 degree requirement.

The sanctioned method (Rule 15(e) of the ILCA Class Rules) to correct this is to wind plastic tape around the front lower rudder box spacer pin (fig 4).

Note: you are not allowed to add material to the front of the rudder to achieve the same effect.

If the rudder angle is significantly less than 78 degrees, you may cut away the rudder where it touches the spacing pin (see Rule 15(d)).

Be careful though, as just 1mm of cut away will result in about 1 degree of rudder movement.

You are always safer to make it slightly less than 78 degrees to allow for wear on the pivot bolt hole and the contact area to the spacing pin (fig 5).

With the availability of fibreglass skinned rudders, the incidence of rudders being significantly below 78 degrees (in conjunction with a modern rudder head) is extremely low.

If required, the gel coat can be wet sanded to fine tune the angle. However, sanding into the laminate will weaken the blade and is not advised.



fig 3



fig 4



fig 5

Instructions for Applying Sail Numbers

PLEASE NOTE THE FOLLOWING DIAGRAMS ARE FOR INFORMATION AND ARE NOT PART OF THE CLASS RULES

Style and Colour

Only self-adhesive, stick on sail numbers and letters may be used. Each one shall be a single, solid colour, and easy to read. The last four numbers on both sides of the sail shall be the same dark colour, preferably black. The numbers in front of the last four shall all be another, obviously different colour, preferably red. National letters are only required at international events, and shall all be the same colour.

Preparation

If the sail is not new, it should be sponged clean with mild soapy water, rinsed and dried. Find a large, clean, flat, hard surface to work on, such as a table or clean wooden floor.

Template

Make a template that each number will just fit inside. See the **Positioning Diagrams** for the minimum sizes of numbers and letters, and template details. They are different for each of the ILCA 7, ILCA 6 and ILCA 4 sails. The template is a rectangle for upright numbers, and a parallelogram for angled numbers.

Base Lines and Limit Lines

Use a pencil to lightly draw **Base Lines** and **Limit Lines** on the sail. The bottom of each number and letter must lie on a **Base Line**. The **Limit Line** is parallel to the leech of the sail, and 100mm from it. The closest letter or number to the leech is positioned to just touch the **Limit Line**. This is shown as the **Start Point** on the Positioning Diagrams. The number or letter should touch the **Limit Line** at the **Base Line** or at any other height, depending on its shape.

Starboard Side Numbers and National Letters

1. Spread the sail out flat on the working surface so that the starboard side of the sail is facing up. The leech (back edge of the sail) will be on the left hand side as shown in the positioning diagrams.
2. **Make sure you are using the correct diagram for the design of sail you are applying the numbers to.** Draw the **Base Line** and **Limit Line** for the starboard numbers (and letters) as shown on the positioning diagram.
3. Before peeling off the backing, place the bottom of the first number on the **Base Line**, with the Start Point touching the **Limit Line**. Use the template with its bottom edge on the **Base Line** to make sure the number is at the correct angle. Pencil around the outline of the number.
4. Peel and fold back about 10mm of the backing from the bottom of the number. Place the number within the pencil outline and press down to stick the peeled back area. Lift the remainder of the number and slowly peel off the backing as you smooth the number onto the sail, taking care to remove air bubbles and creases as you go.
5. If the first number you applied was a 1 (one), measure from the bottom right corner of it and mark a point the space width away along the **Base Line**. The space width is 60mm for ILCA 7 and ILCA 6 sails, and 40mm for ILCA 4 sails - see the appropriate Positioning Diagram. Place your template on the **Base Line** with its lower left corner on the new mark and pencil round the outline of it. Before peeling off the backing of the second number, place it within the pencil outline of the template. Pencil around the outline of the number, and apply it as in point 4, above.
6. If the first number you applied was not a 1 (one), place your template over it and make a pencil mark at the bottom right hand corner. Measure the space width from this mark along the Base Line and make a second pencil mark. Place the template, with its lower left hand corner on the second mark, pencil around the outline and then apply the next number as in point 4, above.
7. When a 1 (one) is to be applied after another number, make sure the appropriate space width between numbers along the **Base Line** is maintained, as shown in the positioning diagram. Use the bottom right hand corner of the template, placed over the preceding number to find the start of the space width on the **Base Line**.
8. Continue marking number positions using the template, the appropriate space widths between template corners, and applying numbers to complete the full sail number. Use the same method to apply national letters if they are required.

Port Side Numbers and National Letters

1. Spread the sail out flat on the working surface so that the port side of the sail is facing up. The leech (back edge of the sail) will be on the right hand side. Draw the **Base Line** for the port numbers (and letters).
2. Start with the letter or number closest to the leech making sure that no part of the number or letter crosses the 100mm **Limit Line** towards the leech. Follow the same method as for the starboard side of the sail, working along the **Base Line** away from the leech towards the luff.

ILCA 4 MKI SAIL NUMBER & LETTER SIZES AND POSITIONING

UPRIGHT NUMBERS AND LETTERS

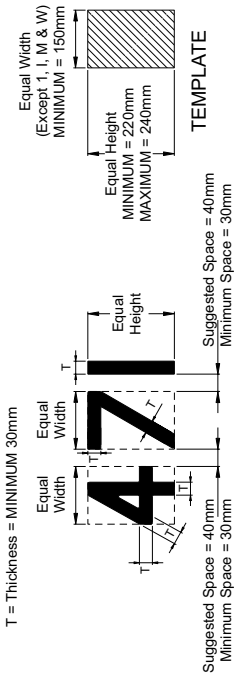

ANGLED NUMBERS AND LETTERS

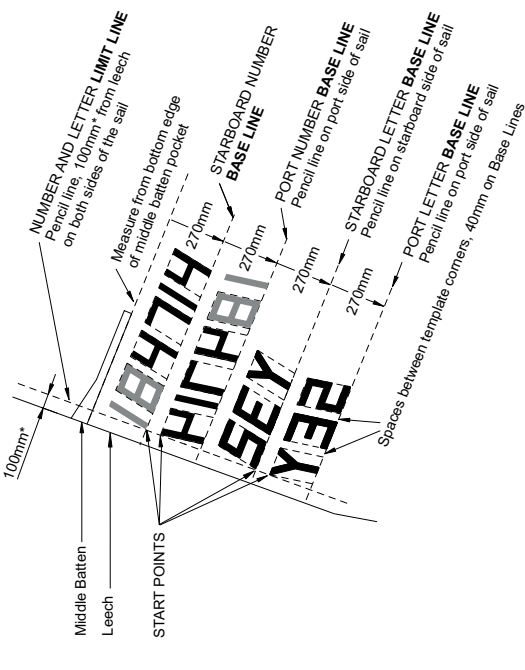
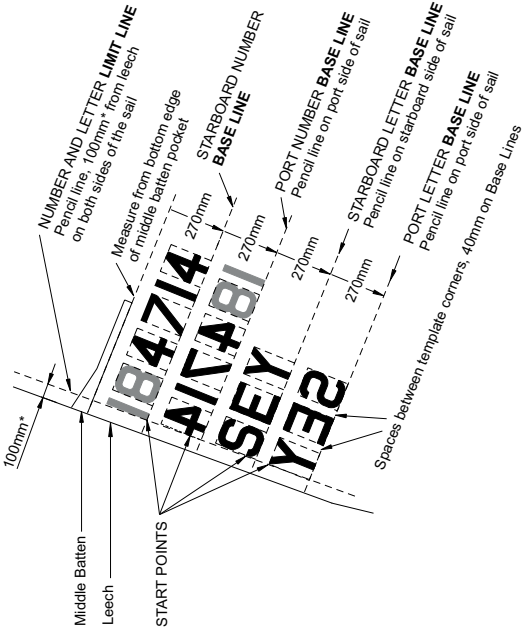
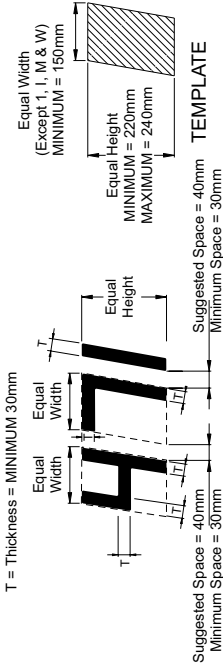

1. MINIMUM SPACE BETWEEN NUMBERS AND LETTERS IN THE CLASS RULES IS 30mm, SO USE 40mm TO ENSURE THAT ANY SMALL ERRORS IN POSITION ARE STILL LEGAL.
 2. LAST FOUR DIGITS OF SAIL NUMBER TO BE ONE DARK, DISTINCTIVE COLOUR OR BLACK, PRECEDING DIGITS TO BE A DIFFERENT, CONTRASTING, DISTINCTIVE COLOUR, PREFERABLY RED. ALL NATIONAL LETTERS TO BE ONE COLOUR. THEY MAY BE ONE OF THE COLOURS OF THE SAIL NUMBER DIGITS OR ANOTHER DISTINCTIVE COLOUR.
- * CLOSEST POINT OF LETTER OR NUMBER SHOULD BE 100mm FROM LEECH, WITH TOLERANCE +/- 12 mm.

PLEASE NOTE DIAGRAMS ARE NOT PART OF THE CLASS RULES

ILCA 4 MKII (BI-RADIAL CUT) SAIL NUMBER & LETTER SIZES AND POSITIONING

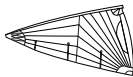

UPRIGHT NUMBERS AND LETTERS

T = Thickness = MINIMUM 30mm

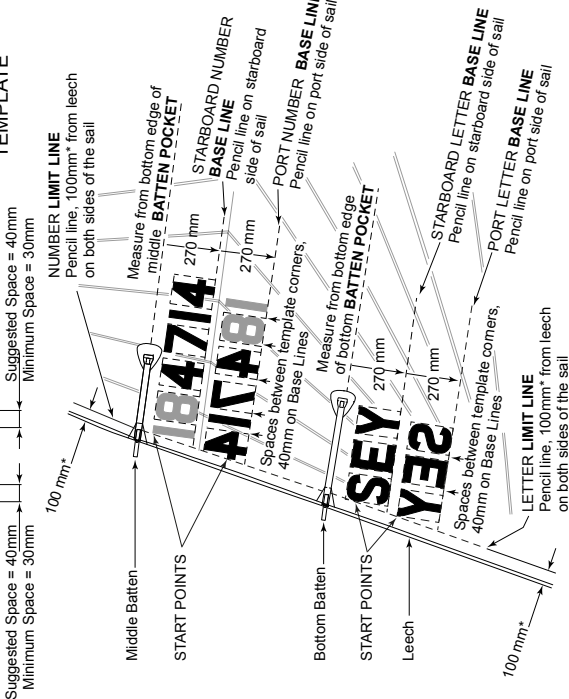
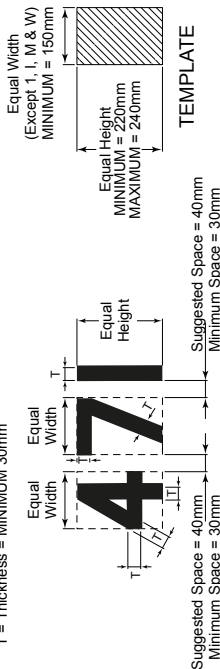

ANGLED NUMBERS AND LETTERS

T = Thickness = MINIMUM 30mm

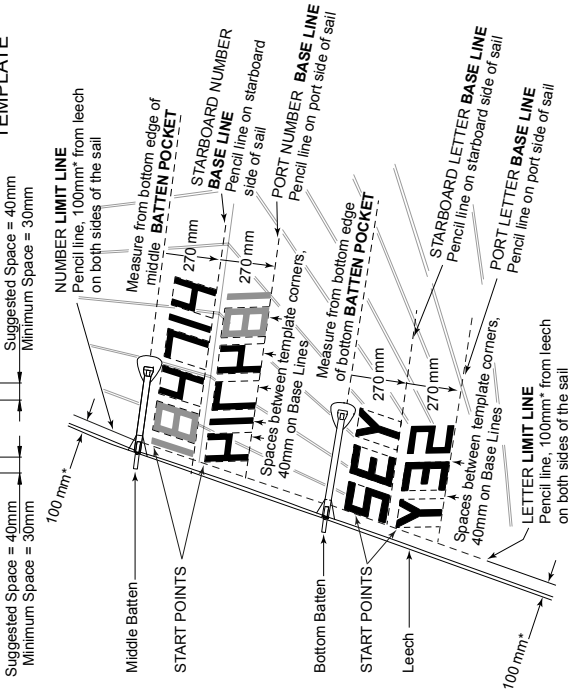
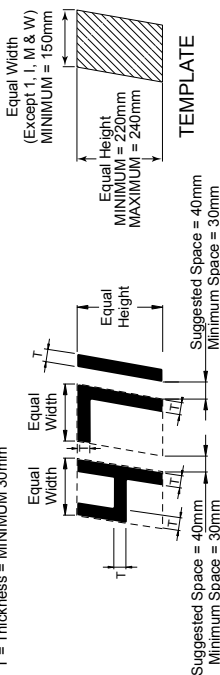

1. MINIMUM SPACE BETWEEN NUMBERS AND LETTERS IN THE CLASS RULES IS 30mm. SO USE 40mm TO ENSURE THAT ANY SMALL ERRORS IN POSITION ARE STILL LEGAL.
2. LAST FOUR DIGITS OF SAIL NUMBER TO BE ONE DARK, DISTINCTIVE COLOUR OR BLACK. PRECEDING DIGITS TO BE A DIFFERENT, CONTRASTING, DISTINCTIVE COLOUR. PREFERABLY RED. ALL NATIONAL LETTERS TO BE ONE COLOUR. THEY MAY BE ONE OF THE COLOURS OF THE SAIL NUMBER DIGITS OR ANOTHER DISTINCTIVE COLOUR.

* CLOSEST POINT OF LETTER OR NUMBER SHOULD BE 100mm FROM LEECH, WITH TOLERANCE +/- 12 mm.

PLEASE NOTE DIAGRAMS ARE NOT PART OF THE CLASS RULES

ILCA 6 SAIL NUMBER & LETTER SIZES AND POSITIONING

UPRIGHT NUMBERS AND LETTERS

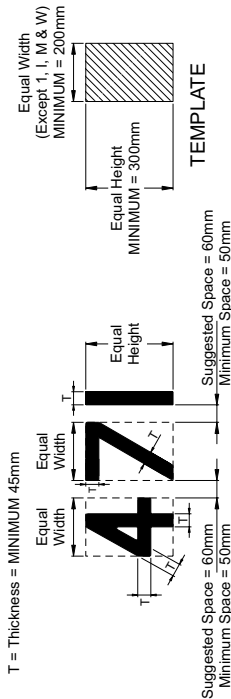

ANGLED NUMBERS AND LETTERS

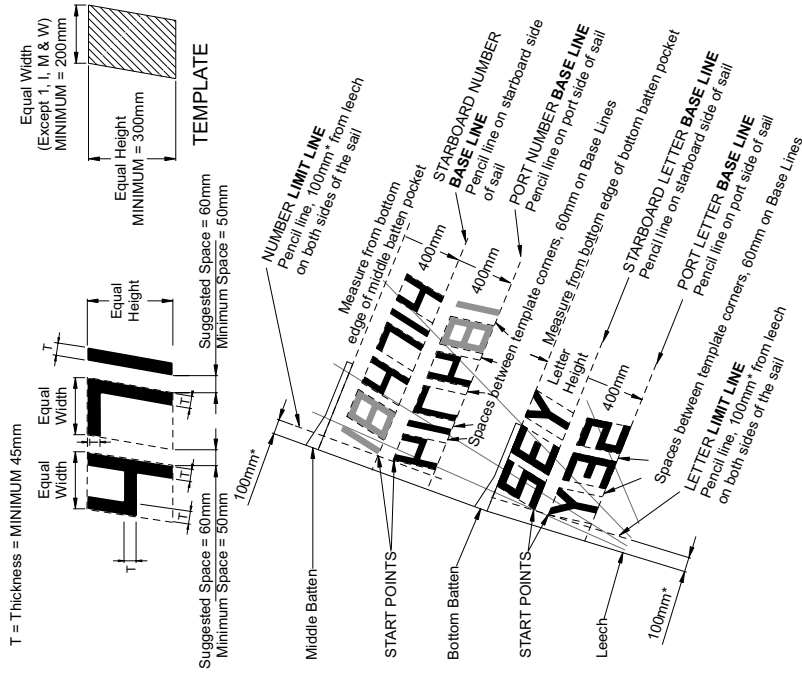

1. MINIMUM SPACE BETWEEN NUMBERS AND LETTERS IN THE CLASS RULES IS 50mm. SO USE 60mm. TO ENSURE THAT ANY SMALL ERRORS IN POSITION ARE STILL LEGAL.
2. LAST FOUR DIGITS OF SAIL NUMBER TO BE ONE DARK, DISTINCTIVE COLOUR OR BLACK. PRECEDING DIGITS TO BE ADIFFERENT, CONTRASTING, DISTINCTIVE, COLOUR, PREFERABLY RED. ALL NATIONAL LETTERS TO BE ONE COLOUR. THEY MAY BE OF THE COLOURS OF THE SAIL NUMBER DIGITS OR ANOTHER DISTINCTIVE COLOUR.

* CLOSEST POINT OF LETTER OR NUMBER SHOULD BE 100mm FROM LEECH, WITH TOLERANCE +/- 12 mm.

PLEASE NOTE DIAGRAMS ARE NOT PART OF THE CLASS RULES

ILCA 7 MKII (BI-RADIAL CUT) SAIL NUMBER & LETTER SIZES AND POSITIONING

November 2021 Edition



UPRIGHT NUMBERS AND LETTERS

T = Thickness = MINIMUM 45mm

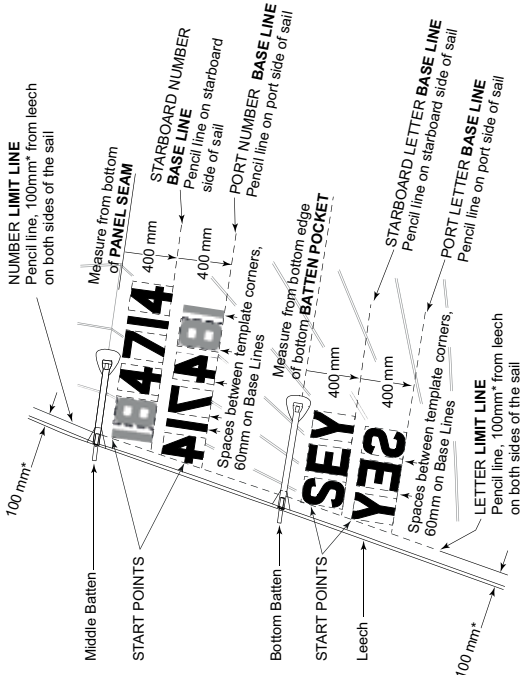
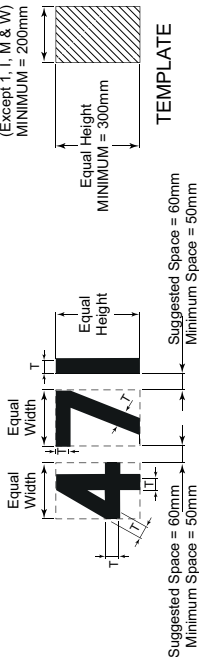

ANGLED NUMBERS AND LETTERS

T = Thickness = MINIMUM 45mm

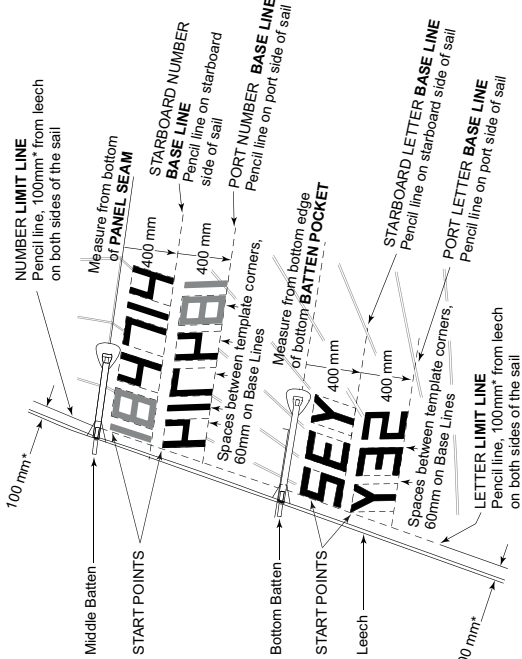
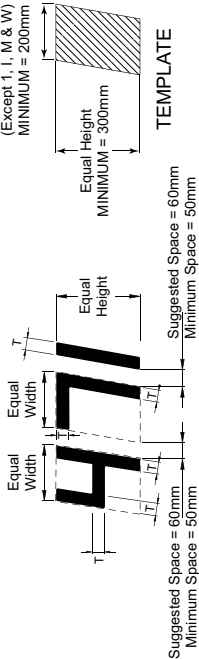

1. MINIMUM SPACE BETWEEN NUMBERS AND LETTERS IN THE CLASS RULES IS 50mm. SO USE 60mm TO ENSURE THAT ANY SMALL ERRORS IN POSITION ARE STILL LEGAL.
2. LAST FOUR DIGITS OF SAIL NUMBER TO BE ONE DARK, DISTINCTIVE COLOUR OR BLACK. PRECEDING DIGITS TO BE A DIFFERENT, CONTRASTING, DISTINCTIVE COLOUR, PREFERABLY RED. ALL NATIONAL LETTERS TO BE ONE COLOUR. THEY MAY BE ONE OF THE COLOURS OF THE SAIL NUMBER DIGITS OR ANOTHER DISTINCTIVE COLOUR.

* CLOSEST POINT OF LETTER OR NUMBER SHOULD BE 100mm FROM LEECH, WITH TOLERANCE +/- 12 mm.

PLEASE NOTE DIAGRAMS ARE NOT PART OF THE CLASS RULES

ILCA 7 MKI (CROSS-CUT) SAIL NUMBER & LETTER SIZES AND POSITIONING

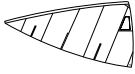

UPRIGHT NUMBERS AND LETTERS

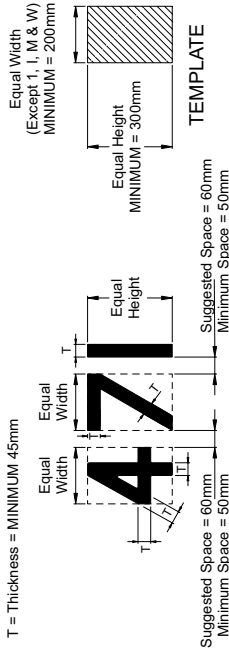

ANGLED NUMBERS AND LETTERS

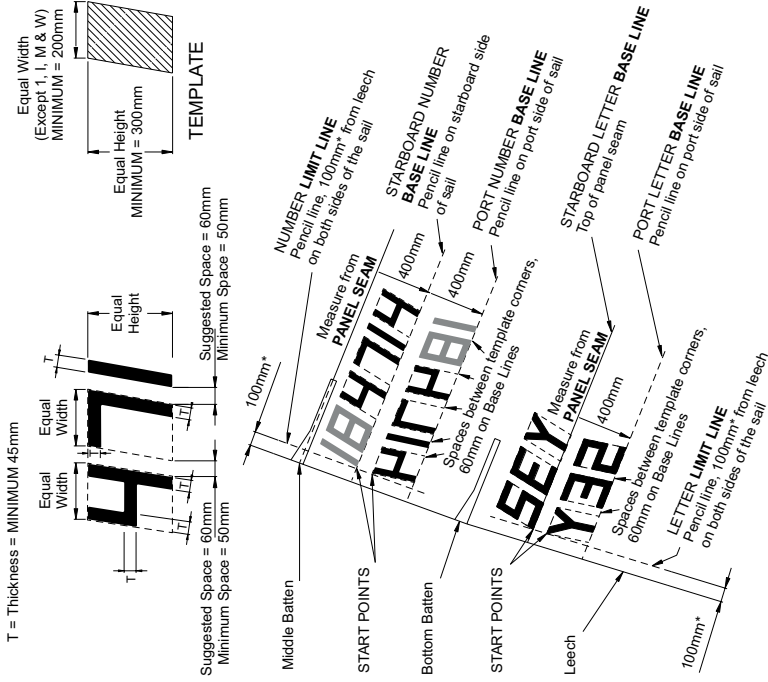

1. MINIMUM SPACE BETWEEN NUMBERS AND LETTERS IN THE CLASS RULES IS 50mm. SO USE 60mm TO ENSURE THAT ANY SMALL ERRORS IN POSITION ARE STILL LEGAL.
2. LAST FOUR DIGITS OF SAIL NUMBER TO BE ONE DARK, DISTINCTIVE COLOUR OR BLACK. PRECEDING DIGITS TO BE A DIFFERENT, CONTRASTING, DISTINCTIVE COLOUR, PREFERABLY RED. ALL NATIONAL LETTERS TO BE ONE COLOUR. THEY MAY BE ONE OF THE COLOURS OF THE SAIL NUMBER DIGITS OR ANOTHER DISTINCTIVE COLOUR.

* CLOSEST POINT OF LETTER OR NUMBER SHOULD BE 100mm FROM LEECH, WITH TOLERANCE +/- 12 mm.

PLEASE NOTE DIAGRAMS ARE NOT PART OF THE CLASS RULES

World Championship Archives

Before 1997, ILCA did not hold separate ILCA 6 (Radial) or Youth Worlds. Except in 1980, entry to the Senior Worlds (ILCA 7/Standard Rig) was restricted.

OLYMPIC GAMES

2024 Paris, France

ILCA 7
Countries 35

| | |
|------------------------|-----|
| 1st Matt Wearn | AUS |
| 2nd Pavlos Kontides | CYP |
| 3rd Stefano Pleschiera | PER |
| 4th Jonatan Vadnai | HUN |
| 5th Hermann Tomasgaard | NOR |

ILCA 6
Countries 44

| | |
|----------------------------|-----|
| 1st Marit Bouwmeester | NED |
| 2nd Anne-Marie Rindom | DEN |
| 3rd Line Flem Hoest | NOR |
| 4th Maud Jayet | FRA |
| 5th Chiara Benini Floriani | ITA |

2020 Tokyo, Japan

Standard
Countries 35

| | |
|------------------------|-----|
| 1st Matt Wearn | AUS |
| 2nd Tonci Stipanovic | CRO |
| 3rd Hermann Tomasgaard | NOR |
| 4th Pavlos Kontides | CYP |
| 5th Philipp Buhl | GER |

Radial
Countries 44

| | |
|-----------------------|-----|
| 1st Anne-Marie Rindom | DEN |
| 2nd Josefín Olsson | SWE |
| 3rd Marit Bouwmeester | NED |
| 4th Emma Plasschaert | BEL |
| 5th Tuula Tenkanen | FIN |

2016 Rio, Brazil

Standard
Countries 46

| | |
|--------------------------|-----|
| 1st Tom Burton | AUS |
| 2nd Tonci Stipanovic | CRO |
| 3rd Sam Meesch | NZL |
| 4th Robert Scheidt | BRA |
| 5th Jean Baptiste Bernaz | FRA |

Radial
Countries 37

| | |
|-----------------------|-----|
| 1st Marit Bouwmeester | NED |
| 2nd Annalisse Murphy | IRL |
| 3rd Anne-Marie Rindom | DEN |
| 4th Evi Van Acker | BEL |
| 5th Tuula Tenkanen | FIN |

2012 London, UK

Standard
Countries 49

| | |
|----------------------|-----|
| 1st Tom Slingsby | AUS |
| 2nd Pavlos Kontides | CYP |
| 3rd Rasmus Mygren | SWE |
| 4th Tonci Stipanovic | CRO |
| 5th Andrew Murdoch | NZL |

Radial
Countries 41

| | |
|-----------------------|-----|
| 1st Lijia Xu | CHN |
| 2nd Marit Bouwmeester | NED |
| 3rd Evi Van Acker | BEL |
| 4th Annalisse Murphy | IRL |
| 5th Alison Young | GBR |

2008 Beijing, CHN

Standard
Countries 43

| | |
|--------------------|-----|
| 1st Paul Goodison | GBR |
| 2nd Vasilij Zbogor | SLO |
| 3rd Diego Romero | ITA |
| 4th Gustavo Lima | POR |
| 5th Andrew Murdoch | NZL |

Radial
Countries 28

| | |
|----------------------------|-----|
| 1st Anna Tunnicliffe | USA |
| 2nd Gintare Volungeviciute | LTU |
| 3rd Lijia Xu | CHN |
| 4th Sarah Blanck | AUS |
| 5th Sarah Steyaert | FRA |

2004 Athens, GRE

Standard
Countries 42

| | |
|----------------------|-----|
| 1st Robert Scheidt | BRA |
| 2nd Andreas Geritzer | AUT |
| 3rd Vasilij Zbogor | SLO |
| 4th Paul Goodison | GBR |
| 5th Gustavo Lima | POR |

2000 Sydney, AUS

Standard
Countries 43

| | |
|-----------------------|-----|
| 1st Ben Ainslie | GBR |
| 2nd Robert Scheidt | BRA |
| 3rd Michael Blackburn | AUS |
| 4th Serge Kats | NED |
| 5th Andreas Geritzer | AUT |

1996 Savannah, USA

Standard
Countries 56

| | |
|-----------------------|-----|
| 1st Robert Scheidt | BRA |
| 2nd Ben Ainslie | GBR |
| 3rd Peer Moberg | NOR |
| 4th Michael Blackburn | AUS |
| 5th Stefan Warkalla | GER |

WORLD CHAMPIONSHIPS

2025 Qingdao, CHN

Open: ILCA 7
Countries 49

| | |
|----------------------|-----|
| 1st Willem Wiersema | NED |
| 2nd Pavlos Kontides | CYP |
| 3rd Zac Littlewood | AUS |
| 4th Jonatan Vadnai | HUN |
| 5th Finley Dickinson | GBR |

Women: ILCA 6
Countries 40

| | |
|----------------------|-----|
| 1st Louise Cervera | FRA |
| 2nd Agata Barwinska | POL |
| 3rd Eve Mcmahon | IRL |
| 4th Anna Munch | DEN |
| 5th Matilda Nicholls | GBR |

2025 Kiel, GER

Men: ILCA 6
Countries 25

| | |
|------------------------------|-----|
| 1st Alessandro Cirinei | ITA |
| 2nd Nicolò Giuseppe Cassitta | ITA |
| 3rd Semen Khashtchina | UKR |
| 4th Otto Dahlberg | FIN |
| 5th John Frederik Wolff | DEN |

2025 San Pedro, USA

Youth Men: ILCA 6
Countries 33

| | |
|------------------------------|-----|
| 1st Alessandro Cirinei | ITA |
| 2nd Josip Tafra | CRO |
| 3rd Joaquin Galvan | ARG |
| 4th Nicolò Giuseppe Cassitta | ITA |
| 5th Alexandros Kyfidis | GRE |

Youth Women: ILCA 6

Countries 31

| | |
|-----------------------|-----|
| 1st Hermionie Ghicas | GRE |
| 2nd Alina Shapovalova | UKR |
| 3rd Feline Van Ede | NED |
| 4th Valentina Araujo | BRA |
| 5th Rebecca Mantel | ISR |

U18 Men: ILCA 4

Countries 31

| | |
|-----------------------------------|-----|
| 1st Konstantinos Portosalte | GRE |
| 2nd Erik Scheidt | LTU |
| 3rd Sadrinhan Suer | TUR |
| 4th Emmanouil Anastasios Vomvylas | GRE |
| 5th Nathan Wehrle | FRA |

U18 Women: ILCA 4

Countries 33

| | |
|--------------------------|-----|
| 1st Blanca Ferrando Babe | ESP |
| 2nd Isabella Suzzo | PER |
| 3rd Derin Barton | TUR |
| 4th Derin Degisen | TUR |
| 5th Eleni Alchanati | GRE |

2025 Dun Laoghaire, IRL

U21 Men: ILCA 7
Countries 35

| | |
|------------------------|-----|
| 1st Ole Schweckendiek | GER |
| 2nd Isaac Schotte | AUS |
| 3rd Athanasios Kyfidis | GRE |
| 4th Edward Reid | AUS |
| 5th George Pilkington | NZL |

U21 Women: ILCA 6

Countries 27

| | |
|------------------------|-----|
| 1st Roos Wind | NED |
| 2nd Emma Mattivi | ITA |
| 3rd Frances Beebe | AUS |
| 4th Ginevra Caracciolo | ITA |
| 5th Evie Saunders | AUS |

2024 Adelaide, AUS

Open: ILCA 7
Countries 52

| | |
|------------------------|-----|
| 1st Matt Wearn | AUS |
| 2nd Hermann Tomasgaard | NOR |
| 3rd Michael Beckett | GBR |
| 4th Philipp Buhl | GER |
| 5th Thomas Saunders | NZL |

2024 Mar del Plata, ARG

Women: ILCA 6
Countries 46

| | |
|-----------------------|-----|
| 1st Anne-Marie Rindom | DEN |
| 2nd Charlotte Rose | USA |
| 3rd Emma Plasschaert | BEL |
| 4th Maud Jayet | SUI |
| 5th Line Flem Hoest | NOR |

Men: ILCA 6

Countries 8

| | |
|------------------------------|-----|
| 1st Francisco Renna | ARG |
| 2nd Juan Pablo Bissio | ARG |
| 3rd Antonio Cavalanti Rosa | BRA |
| 4th Pedro Pinto | ARG |
| 5th Andrey De Oliveira Godoy | BRA |

Youth Men: ILCA 6

Countries 26

| | |
|----------------------|-----|
| 1st Antonio Pascali | ITA |
| 2nd Rem Pulci Magen | ISR |
| 3rd Jake Homberger | USA |
| 4th Gustavo Capovnas | BRA |
| 5th Ramon Frene | ARG |

Youth Women: ILCA 6

Countries 14

| | |
|---------------------------|-----|
| 1st Maria Vittoria Arseni | ITA |
| 2nd Sienna Wright | IRL |
| 3rd Ginevra Caracciolo | ITA |
| 4th Alina Shapovalova | UKR |
| 5th Hermionie Ghicas | GRE |

2024 Viana do Castelo, POR

U18 Men: ILCA 4
Countries 46

| | |
|-----------------------|-----|
| 1st Geras Charabati | CAN |
| 2nd Josip Tafra | CRO |
| 3rd Ali Poyraz Odemir | TUR |
| 4th Benedek Heder | HUN |
| 5th Lorenzo Ghirrotti | ITA |

U18 Women: ILCA 4

Countries 42

| | |
|-----------------------|-----|
| 1st Hieke Schraftrout | NED |
| 2nd Feline Van Ede | NED |
| 3rd Katrina Micallef | MLT |
| 4th Clara Lorenzi | ITA |
| 5th Beata Dokoupilova | CZE |

U21 Men: ILCA 7

Countries 41

| | |
|------------------------|-----|
| 1st Theodor Middelthon | NOR |
| 2nd Anatoli Sassi | ITA |
| 3rd Mattia Cesana | ITA |
| 4th Enrico Tanferna | ITA |
| 5th Javier Segui | ESP |

U21 Women: ILCA 6

Countries 34

| | |
|---------------------------|-----|
| 1st Eve Mcmahon | IRL |
| 2nd Evie Saunders | AUS |
| 3rd Roos Wind | NED |
| 4th Ginevra Caracciolo | ITA |
| 5th Maria Vittoria Arseni | ITA |

2023 The Hague, NED

Open: ILCA 7
Countries 66

| | |
|--------------------------|-----|
| 1st Matt Wearn | AUS |
| 2nd Michael Beckett | GBR |
| 3rd George Gautrey | NZL |
| 4th Jean Baptiste Bernaz | FRA |
| 5th Lorenzo Brando | ITA |

Women: ILCA 6

Countries 56

| | |
|-----------------------|-----|
| 1st Maria Erdi | HUN |
| 2nd Maud Jayet | SUI |
| 3rd Anne-Marie Rindom | DEN |
| 4th Marit Bouwmeester | NED |
| 5th Charlotte Rose | USA |

2023 Dzinwo, POL

Men: ILCA 6
Countries 13

| | |
|-------------------------|-----|
| 1st George Lane | NZL |
| 2nd Nikola Golubovic | MNE |
| 3rd Jon Emmett | GBR |
| 4th Oliver Allen-Wilcox | GBR |
| 5th Terry Hacker | GBR |

Youth Men: ILCA 6

Countries 43

| | |
|------------------------------|--------------|
| Entries 258 | Countries 43 |
| 1st Mattia Cesana | ITA |
| 2nd Dima Karabdzhak | UKR |
| 3rd Hilde Schraftrout | NED |
| 4th Erik Norlén | SWE |
| 5th Nicolò Giuseppe Cassitta | ITA |

Youth Women: ILCA 6

Countries 33

| | |
|---------------------------|--------------|
| Entries 100 | Countries 33 |
| 1st Emma Mattivi | ITA |
| 2nd Ginevra Caracciolo | ITA |
| 3rd Roos Wind | NED |
| 4th Maria Vittoria Arseni | ITA |
| 5th Elena Valencic | SLO |

2023 Volos, GRE

U18 Men: ILCA 4
Countries 48

| | |
|------------------------|--------------|
| Entries 287 | Countries 48 |
| 1st Weka Bhanubandh | THA |
| 2nd James Pine | USA |
| 3rd Lorenzo Ghirrotti | ITA |
| 4th Benedek Heder | HUN |
| 5th Gunes Kumaz Kutsal | TUR |

U18 Women: ILCA 4

Countries 40

| | |
|---------------------------|--------------|
| Entries 150 | Countries 40 |
| 1st Hermionie Ghicas | GRE |
| 2nd Kleopatra Anastassiou | GRE |
| 3rd Alina Shapovalova | UKR |
| 4th Gilda Dononda | FRA |
| 5th Eleni Kalakona Maria | GRE |

U21 Men: ILCA 7

Countries 32

| | |
|----------------------|--------------|
| Entries 115 | Countries 32 |
| 1st Finley Dickinson | GBR |
| 2nd Oskar Madonich | UKR |
| 3rd Caleb Armit | NZL |
| 4th Attilio Borio | ITA |
| 5th Pietro Giacomoni | ITA |

U21 Women: ILCA 6

Countries 27

| | |
|---------------------------|--------------|
| Entries 67 | Countries 27 |
| 1st Eve Mcmahon | IRL |
| 2nd Anja Von Almen | SUI |
| 3rd Carlotta Rizzardi | ITA |
| 4th Ginevra Caracciolo | ITA |
| 5th Maria Vittoria Arseni | ITA |

2022 Riviera Nayarit, MEX

Open: ILCA 7
Countries 45

| | |
|--------------------------|--------------|
| Entries 126 | Countries 45 |
| 1st Jean-Baptiste Bernaz | FRA |
| 2nd Pavlos Kontides | CYP |
| 3rd Filip Juršić | CRO |
| 4th Thomas Saunders | NZL |
| 5th Tonci Stipanovic | CRO |

2022 Texas, USA

Women: ILCA 6
Countries 40

| | |
|-----------------------|--------------|
| Entries 86 | Countries 40 |
| 1st Anne-Marie Rindom | DEN |
| 2nd Maud Jayet | SUI |
| 3rd Emma Plasschaert | BEL |
| 4th Josefín Olsson | SWE |
| 5th Maria Erdi | HUN |

Men: ILCA 6

Countries 34

| | |
|----------------------|--------------|
| Entries 17 | Countries 34 |
| 1st Peter Barnard | USA |
| 2nd William Baker | USA |
| 3rd Hamilton Barclay | USA |
| 4th Nicholas Mueller | USA |
| 5th Thomas Kraak | USA |

2022 Texas, USA

Youth Men: ILCA 6
Countries 33

| | |
|---------------------|--------------|
| Entries 160 | Countries 33 |
| 1st Mattia Cesana | ITA |
| 2nd Erik Norlén | SWE |
| 3rd Caleb Armit | NZL |
| 4th Enrico Tanferna | ITA |
| 5th Robert Meek | USA |

Youth Women: ILCA 6

Countries 19

| | |
|-------------------|--------------|
| Entries 51 | Countries 19 |
| 1st Eve Mcmahon | IRL |
| 2nd Linda Hensel | GER |
| 3rd Lea Peteh | CRO |
| 4th Marga Perello | ESP |
| 5th Emma Mattivi | ITA |

2022 Vilamoura, POR

U18 Men: ILCA 4
Countries 41

| | |
|--------------------------------|--------------|
| Entries 278 | Countries 41 |
| 1st Nicolò Cassitta | ITA |
| 2nd Dionysios Kaipogiannakis | GRE |
| 3rd Max Frank | NED |
| 4th Omer Vered VlienchikISR | ISR |
| 5th Massimiliano AntoniazziITA | ITA |

U18 Women: ICA 4

| | |
|--------------------------|--------------|
| Entries 159 | Countries 36 |
| 1st Ginevra Caracciolo | ITA |
| 2nd Alina Shapovalova | UKR |
| 3rd Petra Marednic | CRO |
| 4th Adrianna Ghicas | GRE |
| 5th Antonia Castro Nuñez | ESP |

U21 Men: ICA 7

| | |
|----------------------|--------------|
| Entries 160 | Countries 39 |
| 1st Ole Schwckendiek | GER |
| 2nd José Mendes | POR |
| 3rd Julian Hoffmann | GER |
| 4th Lorenzo Mayer | FRA |
| 5th Sebastian Kempe | BER |

U21 Women: ICA 6

| | |
|-------------------------|--------------|
| Entries 80 | Countries 32 |
| 1st Elaine Verstraelen | BEL |
| 2nd Eve McMahon | IRL |
| 3rd Giorgia della Valle | ITA |
| 4th Mariëna Makri | CYP |
| 5th Florencia Chiarella | PER |

2021 Barcelona, ESP**Open: ICA 7**

| | |
|-----------------------|--------------|
| Entries 139 | Countries 44 |
| 1st Thomas Saunders | NZL |
| 2nd Finn Lynch | IRL |
| 3rd Tonci Stipanovic | CRO |
| 4th Sergei Komissarov | RYF |
| 5th Zac Littlewood | AUS |

2021 Al Musannah City, OMA**Women: ICA 6**

| | |
|--------------------------|--------------|
| Entries 63 | Countries 30 |
| 1st Emma Plasschaert | BEL |
| 2nd Agata Barwinska | POL |
| 3rd Viktorija Andruleytė | LTU |
| 4th Anne-Marie Rindom | DEN |
| 5th Julia Busselberg | GER |

Men: ICA 6

| | |
|--------------------------|-------------|
| Entries 10 | Countries 6 |
| 1st Nik Pletikos | SLO |
| 2nd Al Muatasem Al Farsi | OMA |
| 3rd Abdul Malik Al Hinal | OMA |
| 4th Umur Eyrirparks | TUR |
| 5th Kare Ratnik | EST |

2021 Arco, ITA**Youth Men: ICA 6**

| | |
|--------------------------|--------------|
| Entries 265 | Countries 38 |
| 1st Mattia Cesana | ITA |
| 2nd Chapman Petersen | USA |
| 3rd Sebastian Kempe | BER |
| 4th Martin Verhulst | SUI |
| 5th Iasonas Kefallonitis | GRE |

Youth Women: ICA 6

| | |
|---------------------|--------------|
| Entries 109 | Countries 30 |
| 1st Eve McMahon | IRL |
| 2nd Anja Von Allmen | SUI |
| 3rd Sara Savelli | ITA |
| 4th Maria Martinez | ESP |
| 5th Alessia Palanti | CZE |

2021 Dun Laoghaire, IRL**U18 Men: ICA 4**

| | |
|------------------------------|--------------|
| Entries 156 | Countries 27 |
| 1st Martins Atilla | LAT |
| 2nd Alexandros Eleftheriadis | GRE |
| 3rd Massimiliano Antoniazzi | ITA |
| 4th Joan Ravie | ESP |
| 5th Hilde Wapstra | NED |

U18 Women: ICA 4

| | |
|------------------------|--------------|
| Entries 87 | Countries 22 |
| 1st Emma Mattivi | ITA |
| 2nd Petra Marednic | CRO |
| 3rd Gaia Bolzonella | ITA |
| 4th Claudia Adán Liadó | ESP |
| 5th Anenjamin Algra | NED |

2021 Gdynia, POL**U21 Men: ICA 7**

| | |
|------------------------|--------------|
| Entries 143 | Countries 37 |
| 1st Zachary Littlewood | AUS |
| 2nd Matteo Paulon | ITA |
| 3rd Julian Hoffmann | GER |
| 4th Bruno Gaspar | CRO |
| 5th Yigit Yalcin Citak | TUR |

U21 Women: ICA 6

| | |
|---------------------------|--------------|
| Entries 60 | Countries 21 |
| 1st Giorgia della Valle | ITA |
| 2nd Chiara Benini Fiorani | ITA |
| 3rd Mariëna Makri | CYP |
| 4th Ana Moncada | ESP |
| 5th Estere Kumpina | LAT |

2020 Melbourne, AUS**Open: Standard**

| | |
|--------------------------|--------------|
| Entries 124 | Countries 44 |
| 1st Philipp Buhl | GER |
| 2nd Matthew Wean | AUS |
| 3rd Tonci Stipanovic | CRO |
| 4th Jean Baptiste Bernaz | FRA |
| 5th Elliot Hanson | GBR |

Women: Radial

| | |
|-----------------------|--------------|
| Entries 105 | Countries 40 |
| 1st Marit Bouwmeester | NED |
| 2nd Maxime Jonker | NED |
| 3rd Line Flem Høst | NOR |
| 4th Anne-Marie Rindom | DEN |
| 5th Magdalena Kwaska | POL |

Men: Radial

| | |
|-----------------------------|--------------|
| Entries 66 | Countries 11 |
| 1st Daniel Krutskikh | RUS |
| 2nd Michael Compton | AUS |
| 3rd Nik Pletikos | SLO |
| 4th Brody Riley | AUS |
| 5th Stefan Elliott-Shircore | AUS |

2019 Sakaiminato-City, JPN**Open: Standard**

| | |
|--------------------|--------------|
| Entries 158 | Countries 57 |
| 1st Tom Burton | AUS |
| 2nd Matthew Wean | AUS |
| 3rd George Gautrey | NZL |
| 4th Sam Meech | NZL |
| 5th Nick Thompson | GBR |

Women: Radial

| | |
|-----------------------|--------------|
| Entries 111 | Countries 49 |
| 1st Anne-Marie Rindom | DEN |
| 2nd Marit Bouwmeester | NED |
| 3rd Alison Young | GBR |
| 4th Emma Plasschaert | BEL |
| 5th Marie Barre | FRA |

Men: Radial

| | |
|---------------------|-------------|
| Entries 32 | Countries 5 |
| 1st Mark Louis | AUS |
| 2nd Zac West | POL |
| 3rd Jan Heuninck | AUS |
| 4th Simon de Gendt | NOR |
| 5th Guilherme Perez | POL |

2019 Kingston, CAN**Youth Men: Radial**

| | |
|------------------------|--------------|
| Entries 161 | Countries 30 |
| 1st Yigit Yalcin Citak | TUR |
| 2nd Amililiano Monos | GRE |
| 3rd Michael Compton | AUS |
| 4th Piotr Malinowski | POL |
| 5th Tom Higgins | IRL |

Youth Women: Radial

| | |
|-----------------------|--------------|
| Entries 48 | Countries 13 |
| 1st Matilda Nicholls | GBR |
| 2nd Paige Caldecoat | AUS |
| 3rd Eve McMahon | IRL |
| 4th Sophia Montgomery | THA |
| 5th Clare Gorman | IRL |

U18 Men: 4.7

| | |
|----------------------|--------------|
| Entries 121 | Countries 33 |
| 1st Toby Coote | AUS |
| 2nd Oliver Gordon | AUS |
| 3rd Ian Louis | AUS |
| 4th Xavier McLachlan | AUS |
| 5th Chris Smith | AUS |

U18 Women: 4.7

| | |
|-------------------|--------------|
| Entries 64 | Countries 20 |
| 1st Mia Lovelady | AUS |
| 2nd Eva Saunders | AUS |
| 3rd Bayley Taylor | AUS |
| 4th Lily Allen | CAN |
| 5th Annalise | AUS |

Balasubramanian. CAN

2019 Split, CRO**U21: Standard**

| | |
|------------------------------|--------------|
| Entries 146 | Countries 42 |
| 1st Juan Pablo Cardozo | ARG |
| 2nd Clemente Seguel Lacamara | ARG |
| 3rd Vishnu Saravanan | IND |
| 4th Yoshihiro Suzuki | JPN |
| 5th Yigit Yalcin Citak | TUR |

U21: Radial Women

| | |
|---------------------------|--------------|
| Entries 71 | Countries 31 |
| 1st Wiktoria Golebiowska | POL |
| 2nd Valeria Lomatchenko | RUS |
| 3rd Maria Kisluhkina | RUS |
| 4th Chiara Benini Fiorani | ITA |
| 5th Mara Stransky | AUS |

2018 Aarhus, DEN**Open: Standard**

| | |
|---------------------|--------------|
| Entries 165 | Countries 66 |
| 1st Pavlos Kontides | CYP |
| 2nd Matthew Wean | AUS |
| 3rd Philipp Buhl | GER |
| 4th Sam Meech | NZL |
| 5th Elliot Hanson | GBR |

Women: Radial

| | |
|-----------------------|--------------|
| Entries 119 | Countries 53 |
| 1st Emma Plasschaert | BEL |
| 2nd Marit Bouwmeester | NED |
| 3rd Anne-Marie Rindom | DEN |
| 4th Monika Mikkola | FIN |
| 5th Paige Railey | USA |

2018 Kiel, GER

| | |
|-----------------------|--------------|
| Men: Radial | Countries 26 |
| 1st Zac Littlewood | AUS |
| 2nd Aleksander Arian | POL |
| 3rd Caelin Winchcombe | AUS |
| 4th Uffe Tomasgaard | NOR |
| 5th Marcin Rudawski | POL |

Youth Men: Radial

| | |
|-------------------------|--------------|
| Entries 373 | Countries 45 |
| 1st Guido Gallinaro | ITA |
| 2nd Josh Armit | NZL |
| 3rd Francesco Viel | ITA |
| 4th Uffe Tomasgaard | NOR |
| 5th Rodolfo Silvestrini | ITA |

Youth Women: Radial

| | |
|-------------------------|--------------|
| Entries 101 | Countries 29 |
| 1st Matilda Talluri | ITA |
| 2nd Matilda Nicholls | GBR |
| 3rd Ana Moncada Sanchez | ESP |
| 4th Julia Busselberg | GER |
| 5th Lillian Myers | USA |

2018 Gdynia, POL**U21: Standard**

| | |
|---------------------|--------------|
| Entries 140 | Countries 41 |
| 1st Philipp Loeue | GER |
| 2nd Max Wilken | GER |
| 3rd Liam Glynn | IRL |
| 4th Jonathan Vadnai | HUN |
| 5th Henry Marshall | USA |

U21: Women: Radial

| | |
|---------------------|--------------|
| Entries 73 | Countries 30 |
| 1st Anna Munch | DEN |
| 2nd Carolina Albano | ITA |
| 3rd Elyse Ainsworth | AUS |
| 4th Dolores Moreira | URU |
| 5th Zoe Thompson | AUS |

U18 Men: 4.7

| | |
|---------------------|--------------|
| Entries 280 | Countries 42 |
| 1st Daniel Hung | SGP |
| 2nd Michael Compton | AUS |
| 3rd Stefano Viale | PER |
| 4th Wonn Kye Lee | SGP |
| 5th Theo Peyre | FRA |

U18 Women: 4.7

| | |
|---------------------------|--------------|
| Entries 158 | Countries 35 |
| 1st Chiara Benini Fiorani | ITA |
| 2nd Simone Chen | SGP |
| 3rd Giorgia Cingolani | ITA |
| 4th Elaine Verstraelen | BEL |
| 5th Marissa Ijben | NED |

2017 Split, CRO**Open: Standard**

| | |
|---------------------|--------------|
| Entries 148 | Countries 52 |
| 1st Pavlos Kontides | CYP |
| 2nd Tom Burton | AUS |
| 3rd Matthew Wean | AUS |
| 4th Philipp Buhl | GER |
| 5th Jesper Stalheim | SWE |

2017 Medemblik, NED**Women: Radial**

| | |
|--------------------------|--------------|
| Entries 99 | Countries 40 |
| 1st Marit Bouwmeester | NED |
| 2nd Evi Van Acker | BEL |
| 3rd Manami Doi | JPN |
| 4th Mathilde De Kerangat | FRA |
| 5th Brenda Bowskill | CAN |

Men: Radial

| | |
|----------------------|--------------|
| Entries 65 | Countries 28 |
| 1st Marcin Rudawski | POL |
| 2nd Eliot Merceron | SUI |
| 3rd Zac Littlewood | AUS |
| 4th Maxime Mazard | FRA |
| 5th Daniel Krutskikh | RUS |

Youth Men: Radial

| | |
|----------------------------|--------------|
| Entries 281 | Countries 44 |
| 1st Dimitris Papadimitriou | GRE |
| 2nd Matias Dietrich | ARG |
| 3rd Nicholas Bezy | HKG |
| 4th Josh Armit | NZL |
| 5th Alexandre Boile | FRA |

Youth Women: Radial

| | |
|--------------------------------|--------------|
| Entries 110 | Countries 32 |
| 1st Hannah Andersson | GBR |
| 2nd Dolores Moreira Frasnchini | URU |
| 3rd Charlotte Rose | USA |
| 4th Emma Savolun | NED |
| 5th Laura Scheve | GER |

2017 Nieuwpoort, BEL**U21: Standard**

| | |
|--------------------------|--------------|
| Entries 125 | Countries 41 |
| 1st Joel Rodriguez Perez | ESP |
| 2nd Jonathan Vadnai | HUN |
| 3rd Daniel Whiteley | GBR |
| 4th Jack Cookson | GBR |
| 5th Sam Whaley | GBR |

U21: Radial Women

| | |
|----------------------|--------------|
| Entries 66 | Countries 27 |
| 1st Maria Erdi | HUN |
| 2nd Hannah Andersson | GBR |
| 3rd Magdalena Kwaska | POL |
| 4th Louise Cervera | FRA |
| 5th Dolores Moreira | URU |

U18 Men: 4.7

| | |
|---------------------------|--------------|
| Entries 235 | Countries 43 |
| 1st Ylikan Timursah | TUR |
| 2nd Sofiane Karim | FRA |
| 3rd Cesare Barabino | ITA |
| 4th Pere Ponseti Mesquida | ESP |
| 5th Finn O'Dea | AUS |

U18 Women: 4.7

| | |
|-------------------------|--------------|
| Entries 116 | Countries 30 |
| 1st Federica Cattarozzi | ITA |
| 2nd Giorgia Cingolani | ITA |
| 3rd Ana Moncada Sanchez | ESP |
| 4th Julia Busselberg | GER |
| 5th Shai Kakon | ISR |

2016 Nuevo Vallarta, MEX**Open: Standard**

| | |
|------------------------------|--------------|
| Entries 113 | Countries 44 |
| 1st Nick Thompson | GBR |
| 2nd Jean-Baptiste Bernaz | FRA |
| 3rd Ruiger Van Schaardenburg | NED |
| 4th Matthew Wean | AUS |
| 5th Marco Gallo | ITA |

Women: Radial

| | |
|--------------------------|--------------|
| Entries 72 | Countries 32 |
| 1st Alison Young | GBR |
| 2nd Paige Railey | USA |
| 3rd Ann-Marie Rindom | DEN |
| 4th Marit Bouwmeester | NED |
| 5th Gintare Volungeviute | LTU |

2016 Dun Laoghaire, IRL**Men: Radial**

| | |
|-------------------------|--------------|
| Entries 42 | Countries 18 |
| 1st Marcin Rudawski | POL |
| 2nd Nik Pletikos | SLO |
| 3rd Martin Manzoli Lowy | BRA |
| 4th Dusan Silvan | IRL |
| 5th Jack Marshall | USA |

Youth Men: Radial

| | |
|-----------------------|--------------|
| Entries 231 | Countries 42 |
| 1st Henry Marshall | USA |
| 2nd Ewan McMahon | IRL |
| 3rd Bernie Chin | SIN |
| 4th Daniel Whiteley | GBR |
| 5th Finnian Alexander | AUS |

Youth Women: Radial

| | |
|---------------------|--------------|
| Entries 76 | Countries 25 |
| 1st Zoe Thomson | AUS |
| 2nd Caroline Rosmo | NOR |
| 3rd Louise Cervera | FRA |
| 4th Sophia Resek | USA |
| 5th Carolina Albano | ITA |

2016 Kiel, GER**U21: Standard**

| | |
|-----------------------|--------------|
| Entries 147 | Countries 38 |
| 1st Jonathan Vadnai | HUN |
| 2nd Joel Rodriguez | ESP |
| 3rd Nik Aaron William | GER |
| 4th Santiago Sampaio | POR |
| 5th Nicolo' Villa | ITA |

U21: Radial Women

| | |
|--------------------------|--------------|
| Entries 59 | Countries 39 |
| 1st Monika Mikkola | FIN |
| 2nd Vasiliea Karachaliou | GRE |
| 3rd Maika Gattler | BEL |
| 4th Valentina Balci | ITA |
| 5th Maud Jayet | SUI |

U18 Men: 4.7

| | |
|------------------------------|--------------|
| Entries 262 | Countries 38 |
| 1st Dimitrios Papadimitriou | GRE |
| 2nd Guido Gallinaro | ITA |
| 3rd Pere Ponseti | ESP |
| 4th Uffe Tomasgaard | NOR |
| 5th Andrey De Oliveira Godoy | BRA |

U18 Women: 4.7

| | |
|-------------------------|--------------|
| Entries 127 | Countries 32 |
| 1st Emma Savolun | NED |
| 2nd Maria Kisluhkina | RUS |
| 3rd Elisa Navoni | ITA |
| 4th Federica Cattarozzi | ITA |
| 5th Juli Baruch | ISR |

2015 Kingston, CAN**Open: Standard**

| | |
|-------------------------|--------------|
| Entries 158 | Countries 62 |
| 1st Nick Thompson | GBR |
| 2nd Philipp Buhl | GER |
| 3rd Tom Burton | AUS |
| 4th Juan Ignacio Maegli | USA |
| 5th Matthew Wean | AUS |

Youth Men: Radial

| | |
|------------------------------|--------------|
| Entries 142 | Countries 34 |
| 1st Connor Nicholas | AUS |
| 2nd Gianmarco Planchestainer | ITA |
| 3rd Nic Baird | USA |
| 4th Paolo Giargia | ITA |
| 5th Umberto Jose Varbaro | ITA |

Youth Women: Radial

| | |
|-----------------------|--------------|
| Entries 53 | Countries 20 |
| 1st Maria Erdi | HUN |
| 2nd Dolores Moreira | URU |
| 3rd Magdalena Kwasna | POL |
| 4th Francesca Bergamo | ITA |
| 5th Carolina Albano | ITA |

2015 AI Musannah City, OMA**Women: Radial**

| | |
|-----------------------|--------------|
| Entries 10 | Countries 49 |
| 1st Ann-Marie Rindom | DEN |
| 2nd Marit Bouwmeester | NED |
| 3rd Evi Van Acker | BEL |
| 4th Tuula Tenkanen | FIN |
| 5th Josefin Olsson | SWE |

2015 Aarhus, DEN**Men: Radial**

| | |
|---------------------------|--------------|
| Entries 75 | Countries 21 |
| 1st Marcin Rudawski | POL |
| 2nd Matthias Van De Loock | BEL |
| 3rd Zan Luka Zelko | SLO |
| 4th Patrick Dopping | DEN |
| 5th Mon Cañellas Salas | ESP |

2015 Membrlik, NED**U21: Standard**

| | |
|---------------------|--------------|
| Entries 155 | Countries 42 |
| 1st Joel Rodriguez | ESP |
| 2nd Michael Beckett | GBR |
| 3rd Benjamin Vadni | HUN |
| 4th Finn Lynch | IRL |
| 5th Jonatan Vadni | HUN |

U21: Radial Women

| | |
|-------------------------|--------------|
| Entries 74 | Countries 33 |
| 1st Maxime Jonker | NED |
| 2nd Line Flem Høst | NOR |
| 3rd Monika Mikkola | FIN |
| 4th Dewi Couvert | NED |
| 5th Martina Reino Cacho | ESP |

U18 Men: 4.7

| | |
|-----------------------------|--------------|
| Entries 257 | Countries 36 |
| 1st A. Bethencourt Fuentes | ESP |
| 2nd Rafael De La Hoz Tuells | ESP |
| 3rd Guido Gallinaro | ITA |
| 4th Toygar Elmas | TUR |
| 5th Alberto Tezza | ITA |

U18 Women: 4.7

| | |
|-------------------------|--------------|
| Entries 127 | Countries 29 |
| 1st Kateryna Gumenko | UKR |
| 2nd Julia Büsselberg | GER |
| 3rd Isaura Maenhaut | BEL |
| 4th Lin Pletikos | SLO |
| 5th Federica Cattarozzi | ITA |

2014 Santander, ESP**Open: Standard**

| | |
|---------------------|--------------|
| Entries 147 | Countries 69 |
| 1st Nicholas Heiner | NED |
| 2nd Tom Burton | AUS |
| 3rd Nick Thompson | GBR |
| 4th Philipp Buhl | GER |
| 5th Robert Scheidt | BRA |

2014 Santander, ESP**Women: Radial**

| | |
|--------------------------|--------------|
| Entries 120 | Countries 55 |
| 1st Marit Bouwmeester | NED |
| 2nd Josefin Olsson | SWE |
| 3rd Evi Van Acker | BEL |
| 4th Tuula Tenkanen | FIN |
| 5th Veronika K. Fenclova | CZE |

2014 Dzinwon, POL**Men: Radial**

| | |
|----------------------|--------------|
| Entries 76 | Countries 22 |
| 1st Stelmazyk Jonasz | POL |
| 2nd Marcin Rudawski | POL |
| 3rd William De smet | BEL |
| 4th Tristan Brown | AUS |
| 5th Maris Pjarskas | LTU |

Youth Men: Radial**Entries 159**

| | |
|--------------------|--------------|
| Entries 159 | Countries 31 |
| 1st Joel Rodriguez | ESP |
| 2nd Nik Willem | GER |
| 3rd Benjamin Wempe | NED |
| 4th Nicol Villa | ITA |
| 5th Jonatan Vadni | HUN |

Youth Women: Radial**Entries 81**

| | |
|----------------------|--------------|
| Entries 81 | Countries 27 |
| 1st Monika Mikkola | FIN |
| 2nd Maria Erdi | HUN |
| 3rd Maite Carlier | BEL |
| 4th Magdalena Kwasna | POL |
| 5th Maud Jayet | SUI |

2014 Douarnenez, FRA**U21: Standard**

| | |
|----------------------------|--------------|
| Entries 105 | Countries 33 |
| 1st Lorenzo Chiavarrini | GBR |
| 2nd Hermant Tomgaard | NOR |
| 3rd Stefano Peschiera | PER |
| 4th Finn Lynch | IRL |
| 5th Joao Souto de Oliveira | BRA |

U21: Radial Women

| | |
|--------------------------|--------------|
| Entries 57 | Countries 23 |
| 1st Agata Barwinska | POL |
| 2nd Daphne Van der Vaart | NED |
| 3rd Martina Reino Cacho | ESP |
| 4th Martha Farugana | ITA |
| 5th Joyce Florida | ITA |

2014 Karatsu, JPN**U18 Men: 4.7**

| | |
|-------------------------|--------------|
| Entries 66 | Countries 21 |
| 1st Alexandre Boite | FRA |
| 2nd Ismael Iess | ESP |
| 3rd Paolo Mavricic | CRO |
| 4th Frederico Fornasari | ITA |
| 5th Kaito Iwaki | JPN |

U18 Women: 4.7

| | |
|-----------------------|--------------|
| Entries 37 | Countries 15 |
| 1st Asya Luvisetto | SUI |
| 2nd Irene Miras Leung | ESP |
| 3rd Francesca Bergamo | ITA |
| 4th Ilaria Rochelli | ITA |
| 5th Maria Kislukhina | RUS |

2013 AI Musannah, OMA**Open: Standard**

| | |
|--------------------------|--------------|
| Entries 112 | Countries 38 |
| 1st Robert Scheidt | BRA |
| 2nd Pavlos Kontides | CYP |
| 3rd Philipp Buhl | GER |
| 4th Rutger Schaardenburg | NED |
| 5th Jesper Stalheim | SWE |

2013 Rizhao City, CHN**Women: Radial**

| | |
|---------------------|--------------|
| Entries 76 | Countries 31 |
| 1st Tina Mihelic | CRO |
| 2nd Tuula Tenkanen | FIN |
| 3rd Paige Railey | USA |
| 4th Dongshang Zhang | CHN |
| 5th Sarah Gunn | DEN |

2013 Dun Laoghaire, IRL**Men: Radial**

| | |
|---------------------------|--------------|
| Entries 95 | Countries 25 |
| 1st Tristan Brown | AUS |
| 2nd Marcin Rudawski | POL |
| 3rd Finn Lynch | IRL |
| 4th Juan Cabrera Gonzales | ESP |
| 5th Sebastian Schneider | ESP |

2013 AI Musannah, OMA**Youth Men: Radial**

| | |
|------------------------------|--------------|
| Entries 51 | Countries 22 |
| 1st Benjamin Vadni | HUN |
| 2nd Gianmarco Planchestainer | ITA |
| 3rd Sebastian Schneider | SUI |
| 4th Ryan Lo | SIN |
| 5th Jonatan Vadni | HUN |

Youth Women: Radial**Entries 28**

| | |
|--------------------------|--------------|
| Entries 28 | Countries 17 |
| 1st Monika Mikkola | FIN |
| 2nd Celine Therese Herud | NOR |
| 3rd Line Flem Host | NOR |
| 4th Jillian Lee | SIN |
| 5th Agata Barwinska | POL |

U13 Balatonfured, HUN**U21: Standard**

| | |
|-------------------------|--------------|
| Entries 138 | Countries 34 |
| 1st Matthew Kennedy | AUS |
| 2nd Hermant Tomgaard | NOR |
| 3rd Francesco Marrai | ITA |
| 4th Lorenzo Chiavarrini | GBR |
| 5th Giovanni Cocoluto | ITA |

U21: Radial Women**Entries 96**

| | |
|-----------------------|--------------|
| Entries 96 | Countries 32 |
| 1st Svenja Weger | GER |
| 2nd Niki Blossar | FIN |
| 3rd Claretta Tempesti | ITA |
| 4th Manami Doi | JPN |
| 5th Kim Pletikos | SLO |

U18 Men: 4.7**Entries 239**

| | |
|------------------------------|--------------|
| Entries 239 | Countries 46 |
| 1st Anil Cetin | TUR |
| 2nd Jonatan Vadni | HUN |
| 3rd Conor Nicholas | AUS |
| 4th Gianmarco Planchestainer | ITA |
| 5th Sergio Silva | PER |

U18 Women: 4.7**Entries 130**

| | |
|-----------------------------|--------------|
| Entries 130 | Countries 33 |
| 1st Silvia Morales Gonzalez | ESP |
| 2nd Magdalena Kwasna | POL |
| 3rd Sofia Capparuwaci | ITA |
| 4th Alba Elejabertia | ESP |
| 5th Jose Maria Marichal | ESP |

2012 Boltenhagen, GER**Open: Standard**

| | |
|--------------------|--------------|
| Entries 169 | Countries 62 |
| 1st Tom Slingsby | AUS |
| 2nd Tonci Stanovic | CRO |
| 3rd Andrew Maloney | NZL |
| 4th Juan Maegi | GUA |
| 5th Tom Burton | AUS |

Women: Radial

| | |
|-----------------------|--------------|
| Entries 136 | Countries 53 |
| 1st Gintare Scheidt | LTU |
| 2nd Lijia Xu | CHN |
| 3rd San Multala | FIN |
| 4th Alison Young | NED |
| 5th Marit Bouwmeester | GBR |

2012 Buenos Aires, ARG**U21: Standard**

| | |
|--------------------------|--------------|
| Entries 29 | Countries 19 |
| 1st Giovanni Cocoluto | ITA |
| 2nd Stig Steinfurth | DEN |
| 3rd Aleksandr Arian | POL |
| 4th Juan Ignacio Biava | ARG |
| 5th Ignasi López Carcaré | ESP |

2012 Brisbane, AUS**Men: Radial**

| | |
|----------------------|-------------|
| Entries 54 | Countries 9 |
| 1st Tristan Brown | AUS |
| 2nd Matthew Wearn | AUS |
| 3rd Jeremy O'Connell | AUS |
| 5th Mahia Pepper | NZL |
| 5th Daniel Smith | AUS |

Youth Men: Radial

| | |
|-------------------------|--------------|
| Entries 71 | Countries 11 |
| 1st Hermant Tomgaard | NOR |
| 2nd Andrew Mckenzie | NZL |
| 3rd Mitchell Kiss | USA |
| 4th Maxim Nikolaev | RUS |
| 5th Juan Carlos Perdomo | PUR |

Youth Women: Radial

| | |
|---------------------|--------------|
| Entries 35 | Countries 19 |
| 1st Maxime Jonker | NED |
| 2nd Madison Kennedy | AUS |
| 3rd Georgina Povall | GBR |
| 4th Milly Bennett | AUS |
| 5th Anna Phillip | AUS |

2012 Buenos Aires, ARG**U18 Men: 4.7**

| | |
|----------------------------|--------------|
| Entries 71 | Countries 25 |
| 1st Benjamin Vadni | HUN |
| 2nd Nahuel Rodriguez Pérez | ESP |
| 3rd Maximilian Kuester | ITA |
| 4th Jacopo Fanti | ITA |
| 5th Raul Sanchez Lago | ESP |

U16 Men: 4.7

| | |
|--------------------------|--------------|
| Entries 20 | Countries 12 |
| 1st Joel Rodriguez Pérez | ESP |
| 2nd Malone Chao Jie Pun | SIN |
| 3rd Luka Tomic | SRE |
| 4th Daniel Carrozo | ARG |
| 5th Francisco Guaragna | ARG |

U18 Women: 4.7

| | |
|----------------------------|--------------|
| Entries 46 | Countries 17 |
| 1st Celine Therese Herud | NOR |
| 2nd Yolanda Luque Gonzalez | ESP |
| 3rd Anja Hamerlitz | CRO |
| 4th Júlia Silva | BRA |
| 5th Martina Reino Cacho | ESP |

U16 Women: 4.7

| | |
|---------------------------|-------------|
| Entries 12 | Countries 7 |
| 1st Maria C. K. Boabaid | BRA |
| 2nd Natalia A. S. Barriga | ESP |
| 3rd Jacinta Ainsworth | AUS |
| 4th Kana Hayashi | JPN |

2011 Perth, AUS**Open: Standard**

| | |
|------------------------|--------------|
| Entries 145 | Countries 66 |
| 1st Tom Slingsby | AUS |
| 2nd Simon Groteluschen | GER |
| 3rd Nick Thompson | GBR |
| 4th Andreas Getzter | AUT |
| 5th Paul Goodison | GBR |

Women: Radial

| | |
|----------------------------|--------------|
| Entries 102 | Countries 51 |
| 1st Marit Bouwmeester | NED |
| 2nd Evi Van Acker | BEL |
| 3rd Paige Railey | USA |
| 4th Veronika Fenclova | CZE |
| 5th Gintare Volungeviciute | LTU |

2011 La Rochelle, FRA**U21: Standard**

| | |
|--------------------------|--------------|
| Entries 151 | Countries 40 |
| 1st Sam Meech | NZL |
| 2nd Alex Mills-Barton | GBR |
| 3rd Martin Evans | GBR |
| 4th Ki-Raphael Sulkowski | AUS |
| 5th Francesco Marrai | ITA |

2011 La Rochelle, FRA**Men: Radial**

| | |
|-------------------------|--------------|
| Entries 135 | Countries 35 |
| 1st Marcin Rudawski | POL |
| 2nd James Burman | AUS |
| 3rd Yrui Hummel | NED |
| 4th Tristan Brown | AUS |
| 5th Juan Carlos Perdomo | PUR |

Youth Men: Radial

| | |
|-----------------------|--------------|
| Entries 277 | Countries 42 |
| 1st Giovanni Cocoluto | ITA |
| 2nd Elliot Hanson | GBR |
| 3rd Eliot Merceron | FRA |
| 4th Mitchell Kiss | USA |
| 5th Tommaso Centonze | ITA |

Youth Women: Radial

| | |
|-------------------------|--------------|
| Entries 101 | Countries 27 |
| 1st Erika Reineke | USA |
| 2nd Oren Jacob | ISR |
| 3rd Sandy Fauthoux | FRA |
| 4th Paulina Zubachowska | POL |
| 5th Manami Doi | JPN |

2011 San Francisco, USA**U18 Men: 4.7**

| | |
|---------------------------|--------------|
| Entries 112 | Countries 28 |
| 1st Francisco Gonzalez S. | ESP |
| 2nd Carlos Rosello | ESP |
| 3rd William de Smet | BEL |
| 4th Keiju Okada | JPN |
| 5th Mehmet Turkmen | TUR |

U16 Men: 4.7

| | |
|---------------------|--------------|
| Entries 39 | Countries 22 |
| 1st Nils Theuninck | SUI |
| 2nd Anthony Parke | GBR |
| 3rd Martin Lowy | BRA |
| 4th Nicholas Connor | AUS |
| 5th Trent Rippey | NZL |

U18 Women: 4.7

| | |
|--------------------------|--------------|
| Entries 53 | Countries 19 |
| 1st Cecilia Zorzi | ITA |
| 2nd Kim Pletikos | SLO |
| 3rd Line Flem Høst | NOR |
| 4th Celine Therese Herud | NOR |
| 5th Maud Jayet | SUI |

U16 Women: 4.7

| | |
|--------------------------|-------------|
| Entries 12 | Countries 8 |
| 1st Maud Jayet | SUI |
| 2nd Athanasia Fakidi | GRE |
| 3rd Vasileia Karachaliou | GRE |
| 4th Savannah Siew K. Hui | SIN |
| 5th Marine V.Campenhout | SUI |

2010 Hayling Island, GBR**Open: Standard**

| | |
|---------------------|--------------|
| Entries 160 | Countries 53 |
| 1st Tom Slingsby | AUS |
| 2nd Nick Thompson | GBR |
| 3rd Andrew Murdoch | NZL |
| 4th Andrew Gargay | AUS |
| 5th Pavlos Kontides | CYP |

U21: Standard

| | |
|------------------------|--------------|
| Entries 137 | Countries 37 |
| 1st Thorbjørn Schierup | DEN |
| 2nd Francesco Marrai | ITA |
| 3rd Alex Mills-Barton | GBR |
| 4th Kacper Ziemiński | POL |
| 5th Filip Jurisic | CRO |

2010 Largs, GBR**Women: Radial**

| | |
|--------------------------|--------------|
| Entries 117 | Countries 41 |
| 1st Sari Multala | FIN |
| 2nd Marit Bouwmeester | NED |
| 3rd Paige Railey | USA |
| 4th Sarah Stierdt | FRA |
| 5th Tatiana Drozdovskaya | BLR |

Men: Radial

| | |
|---------------------|--------------|
| Entries 103 | Countries 31 |
| 1st Marcin Rudawski | POL |
| 2nd Wojciech Zemke | POL |
| 3rd Mitchell Kiss | USA |
| 4th Ben Koppelaar | NED |
| 5th Insub Kim | KOR |

Youth Men: Radial

| | |
|------------------------|--------------|
| Entries 228 | Countries 41 |
| 1st Giovanni Cocoluto | ITA |
| 2nd Tadeusz Kubiak | POL |
| 3rd Luca Antognoli | ITA |
| 4th Stefano Mazzaferro | BRA |
| 5th Mitchell Kiss | USA |

Youth Women: Radial

| | |
|---------------------------|--------------|
| Entries 91 | Countries 26 |
| 1st Erika Reineke | USA |
| 2nd Manami Doi | JPN |
| 3rd Michelle Broekhuizen | NED |
| 4th Chiara Steinmueller | GER |
| 5th Arjonilla Julia Vallo | ESP |

2010 Pattaya, THA

| | |
|-------------------------|--------------|
| U18 Men: 4.7 | |
| Entries 45 | Countries 22 |
| 1st Etienne Le Pen | FRA |
| 2nd Supakorn Pongwichan | THA |
| 3rd Jobert Van Dijk | NED |
| 4th Luca Malusa | ITA |
| 5th Juan Carlos Perdomo | PUR |

U18 Women: 4.7

| | |
|----------------------|--------------|
| Entries 40 | Countries 20 |
| 1st Caitlin Elks | AUS |
| 2nd Nur Amirah Hamid | MAS |
| 3rd Oren Jacob | ISR |
| 4th Ashlie Lane | AUS |
| 5th Ella Evers | AUS |

U16 Mixed: 4.7

| | |
|------------------------|--------------|
| Entries 31 | Countries 14 |
| 1st Ryan Amlehn | NZL |
| 2nd Mark Spearman | AUS |
| 3rd Filipos Florentin | GRE |
| 4th Panagiotis Stathis | GRE |
| 5th Benjamin Whiteside | NZL |

2009 Halifax, CAN**Open: Standard**

| | |
|----------------------|--------------|
| Entries 168 | Countries 51 |
| 1st Paul Goodison | GBR |
| 2nd Michael Burt | NZL |
| 3rd Nick Thompson | GBR |
| 4th Julio Alsogaray | ARG |
| 5th Tonci Stipanovic | CRO |

2009 Karatsu, JPN**Women: Radial**

| | |
|-------------------------|--------------|
| Entries 88 | Countries 30 |
| 1st Sari Muiltala | FIN |
| 2nd Sophie de Turckheim | FRA |
| 3rd Anna Tunnicliffe | USA |
| 4th Marit Bouwmeester | NED |
| 5th Lijia Xu | CHN |

Men: Radial

| | |
|------------------------|--------------|
| Entries 61 | Countries 16 |
| 1st Marcin Rudawski | POL |
| 2nd Ben Koppelaar | NED |
| 3rd Insub Kim | KOR |
| 4th Hisaki Nagai | JPN |
| 5th Mohd Romi Muhammad | MAS |

Youth Men: Radial

| | |
|----------------------|--------------|
| Entries 100 | Countries 25 |
| 1st Keerati Bualong | THA |
| 2nd Aleksander Arian | POL |
| 3rd Filip Kobieliski | POL |
| 4th Toma Visic | CRO |
| 5th Chris Barnard | USA |

Youth Women: Radial

| | |
|--------------------------|--------------|
| Entries 39 | Countries 16 |
| 1st Mathilde de Kerangat | FRA |
| 2nd Ashley Stoddart | AUS |
| 3rd Michelle Broekhuizen | NED |
| 4th Anna Agrafioti | GRE |
| 5th Joanna Maksymiuk | POL |

2009 Buzios, BRA**Youth Men: 4.7**

| | |
|-------------------------|--------------|
| Entries 109 | Countries 24 |
| 1st Jonathan Martinetti | ECU |
| 2nd Hermann Tommasgaard | NOR |
| 3rd Juraj Divjakinja | CRO |
| 4th Guillermo Arce | PER |
| 5th Tono Alcazar | ESP |

Youth Women: 4.7

| | |
|---------------------------|--------------|
| Entries 39 | Countries 23 |
| 1st Urska Kosir | SLO |
| 2nd Tomoyo Wakabayashi | JPN |
| 3rd Hitomi Murayama | JPN |
| 4th Kim Pletikos | SLO |
| 5th Patricia Coro Leveque | ESP |

2008 Terrigal, AUS**Open: Standard**

| | |
|----------------------|--------------|
| Entries 157 | Countries 58 |
| 1st Tom Slingsby | AUS |
| 2nd Julio Alsogaray | ARG |
| 3rd Javier Hernandez | ESP |
| 4th Vasilij Zbogor | SLO |
| 5th Michael Bullot | NZL |

2008 Auckland, NZL**Women: Radial**

| | |
|----------------------------|--------------|
| Entries 116 | Countries 41 |
| 1st Sarah Steyaert | FRA |
| 2nd Lijia Xu | CHN |
| 3rd Andrea Brewster | GBR |
| 4th Gintare Volungeviciute | LTU |
| 5th Sarah Black | AUS |

Men: Radial

| | |
|-------------------|--------------|
| Entries 71 | Countries 17 |
| 1st Michael Leigh | CAN |
| 2nd Brad Funk | USA |
| 3rd Simon Morgan | AUS |
| 4th James Sandall | NZL |
| 5th James Burman | AUS |

Youth Men: Radial

| | |
|-------------------------|--------------|
| Entries 85 | Countries 20 |
| 1st Andrew Maloney | NZL |
| 2nd Martin Evans | GBR |
| 3rd Maarten Max Moerman | NED |
| 4th Tom Burton | CAN |
| 5th Sam Meech | NZL |

Youth Women: Radial

| | |
|--------------------------|--------------|
| Entries 38 | Countries 14 |
| 1st Gabrielle King | AUS |
| 2nd Cushman Hume-Merry | NZL |
| 3rd Sarah Gunn | DEN |
| 4th Mathilde de Kerangat | FRA |
| 5th Anaisse Murphy | IRL |

2008 Trogir, CRO**Youth Men: 4.7**

| | |
|--------------------------|--------------|
| Entries 279 | Countries 43 |
| 1st Shahar Jacob | ISR |
| 2nd Scott Sydney | SIN |
| 3rd Lovre Perhat | CRO |
| 4th Toma Visic | CRO |
| 5th Alexandros Chocholis | GRE |

Youth Women: 4.7

| | |
|---------------------------|--------------|
| Entries 116 | Countries 32 |
| 1st Elizabeth Yin | SIN |
| 2nd Matea Senkic | CRO |
| 3rd Antea Kordic | CRO |
| 4th Cora Leveque Patricia | ESP |
| 5th Charlotte Asselt | NED |

2007 Cascais, POR**Open: Standard**

| | |
|--------------------|--------------|
| Entries 149 | Countries 60 |
| 1st Tom Slingsby | AUS |
| 2nd Andrew Murdoch | NZL |
| 3rd Dennis Karpak | EST |
| 4th Mate Arapov | CRO |
| 5th Paul Goodison | GBR |

Women: Radial

| | |
|--------------------------|--------------|
| Entries 107 | Countries 48 |
| 1st Tatiana Drozdovskaya | BLR |
| 2nd Sari Muiltala | FIN |
| 3rd Petra Niemann | GER |
| 4th Katarzyna Szotynska | POL |
| 5th Anna Tunnicliffe | USA |

2007 The Hague, NED**Men: Radial**

| | |
|--------------------|--------------|
| Entries 121 | Countries 26 |
| 1st Ben Paton | GBR |
| 2nd Eduardo Vianen | NED |
| 3rd Steven Krol | NED |
| 4th Jon Emmett | GBR |
| 5th James Burman | AUS |

Youth Men: Radial

| | |
|------------------------|--------------|
| Entries 204 | Countries 29 |
| 1st Thorbjorn Schierup | DEN |
| 2nd Filip Mitkakis | GRE |
| 3rd Gijs Pel | NED |
| 4th Joaquin Blanco | ESP |
| 5th Barbaros Tuna | TUR |

Youth Women: Radial

| | |
|--------------------------|--------------|
| Entries 68 | Countries 26 |
| 1st Tuula Tenkanen | FIN |
| 2nd Susana Romero | ESP |
| 3rd Sarah Gunn | DEN |
| 4th Anne Haeger | CAN |
| 5th Mathilde de Kerangat | FRA |

2007 Hermanus, RSA**Youth Men: 4.7**

| | |
|--------------------------|--------------|
| Entries 95 | Countries 27 |
| 1st Filip Pitka | CRO |
| 2nd Baepi Pinna | BRA |
| 3rd Alexander Zimmermann | PER |
| 4th Boris Bignoli | ITA |
| 5th Jakob Bozic | SLO |

Youth Women: 4.7

| | |
|-------------------|--------------|
| Entries 25 | Countries 14 |
| 1st Tajana Ganic | CRO |
| 2nd Ewa Makowska | POL |
| 3rd Lina Stasic | CRO |
| 4th Tiffany Brien | IRL |
| 5th Matea Senkic | CRO |

2006 Jeju Island, KOR**Open: Standard**

| | |
|-----------------------|--------------|
| Entries 128 | Countries 43 |
| 1st Michael Blackburn | AUS |
| 2nd Tom Slingsby | AUS |
| 3rd Rasmus Myrgen | SWE |
| 4th Michael Leigh | CAN |
| 5th Gustavo Lima | POR |

2006 Los Angeles, USA**Men: Radial**

| | |
|---------------------|--------------|
| Entries 71 | Countries 22 |
| 1st Fabio Pillar | BRA |
| 2nd Steven Le Fevre | NED |
| 3rd Steven Krol | NED |
| 4th Jon Emmett | GBR |
| 5th Ryan Seaton | IRL |

Women: Radial

| | |
|-----------------------------|--------------|
| Entries 89 | Countries 31 |
| 1st Lijia Xu | CHN |
| 2nd Petra Niemann | GER |
| 3rd Tania Elias Calles Wolf | MEX |
| 4th Anna Tunnicliffe | USA |
| 5th Evi Van Ecker | BEL |

Youth Men: Radial

| | |
|----------------------------|--------------|
| Entries 140 | Countries 21 |
| 1st Kyle Rogachenko | USA |
| 2nd Guilherme Barbosa Lima | BRA |
| 3rd Mathew Archibald | CAN |
| 4th Joaquin Blanco | ESP |
| 5th James Sandall | NZL |

Youth Women: Radial

| | |
|---------------------|--------------|
| Entries 39 | Countries 12 |
| 1st Claire Dennis | USA |
| 2nd Susana Romero | ESP |
| 3rd Allie Blecher | USA |
| 4th Laura Maes | BEL |
| 5th Stephanie Roble | USA |

2006 Hourtin, FRA**Youth Men: 4.7**

| | |
|----------------------|--------------|
| Entries 237 | Countries 27 |
| 1st Colin Xinn Cheng | SIN |
| 2nd Victor Serezhkin | RUS |
| 3rd Marko Peresa | CRO |
| 4th Fran Pericic | CRO |
| 5th Giuseppe Linares | ITA |

Youth Women: 4.7

| | |
|--------------------------|--------------|
| Entries 88 | Countries 19 |
| 1st Victoria Chan | SIN |
| 2nd Agnieszka Skrzypulec | POL |
| 3rd Julie Chehab | FRA |
| 4th Susana Romero | ESP |
| 5th Tuula Tenkanen | FIN |

2005 Fortaleza, BRA**Open: Standard**

| | |
|-------------------------|--------------|
| Entries 136 | Countries 36 |
| 1st Robert Scheidt | BRA |
| 2nd Diego Emilio Romero | ARG |
| 3rd Andrew Murdoch | NZL |
| 4th Vasilij Zbogor | SLO |
| 5th Mate Arapov | CRO |

Men: Radial

| | |
|------------------------|--------------|
| Entries 90 | Countries 24 |
| 1st Eduardo Magalhães | BRA |
| 2nd Brad Funk | USA |
| 3rd Blair McLay | NZL |
| 4th Martin Jenkins | ARG |
| 5th Andreas Perdicaris | BRA |

Women: Radial

| | |
|-------------------------|--------------|
| Entries 76 | Countries 31 |
| 1st Paige Railey | USA |
| 2nd Sophie de Turckheim | FRA |
| 3rd Anna Tunnicliffe | USA |
| 4th Petra Niemann | GER |
| 5th Krystal Weir | AUS |

Youth Men: Radial

| | |
|-----------------------|--------------|
| Entries 77 | Countries 23 |
| 1st Blair McLay | NZL |
| 2nd Frederico Melo | POR |
| 3rd Ivan Taritas | CRO |
| 4th Antonios Tzortzis | GRE |
| 5th James Burman | AUS |

Youth Women: Radial

| | |
|-------------------------|--------------|
| Entries 26 | Countries 13 |
| 1st Veronika Hadravsky | AUT |
| 2nd Brnisa Corderiro | BRA |
| 3rd Viviane de Oliveira | BRA |
| 4th Luiza de Saboia | BRA |
| 5th Cecilia de Andrade | BRA |

2005 Barrington, USA**Entries 92**

| | |
|-----------------------|--------------|
| Entries 92 | Countries 16 |
| Youth Men: 4.7 | |
| 1st Joaquin Blanco | ESP |
| 2nd Adam Sims | GBR |
| 3rd Dany Stanicic | SLO |
| 4th Guney Kaptan | TUR |
| 5th Marco Teixidor | PUR |

Youth Women: 4.7

| | |
|---------------------|--------------|
| Entries 31 | Countries 13 |
| 1st Stephanie Roble | USA |
| 2nd Annie Haeger | USA |
| 3rd Cecilia Aragao | BRA |
| 4th Matilde Fabri | ITA |
| 5th Niilsu Orgen | TUR |

2004 Bitez, TUR**Open: Standard**

| | |
|-----------------------|--------------|
| Entries 145 | Countries 60 |
| 1st Robert Scheidt | BRA |
| 2nd Mark Mendelblatt | USA |
| 3rd Michael Blackburn | AUS |
| 4th Hamish Pepper | NZL |
| 5th Karl Suneson | SWE |

2004 Brisbane, AUS

| | |
|-----------------------|--------------|
| Men: Radial | |
| Entries 133 | Countries 11 |
| 1st Michael Blackburn | AUS |
| 2nd Aron Lolic | CRO |
| 3rd Tom Slingsby | AUS |
| 4th Blair McLay | NZL |
| 5th Marc Orams | NZL |

Women: Radial

| | |
|-----------------------------|--------------|
| Entries 37 | Countries 12 |
| 1st Krystal Weir | AUS |
| 2nd Christine Bridge | AUS |
| 3rd Cecilia Carranza Saroli | ARG |
| 4th Nufar Edelmann | ISR |
| 5th Gea Juljens | NED |

Youth: Radial

| | |
|--------------------------|--------------|
| Entries 108 | Countries 18 |
| 1st Jean Baptiste Bernaz | FRA |
| 2nd Nathan Outeridge | AUS |
| 3rd Daniel Mihelic | CRO |
| 4th Daniel Jakobsson | BRA |
| 5th Javier Padron | ESP |

2004 Riva del Garda, ITA**Entries 276**

| | |
|---------------------------|--------------|
| Entries 276 | Countries 23 |
| Youth Men: 4.7 | |
| 1st Justin Onwieke | RSA |
| 2nd Mathieu Frei | FRA |
| 3rd Ivo Kalabic | CRO |
| 4th Alexander Dolan | IRL |
| 5th Pierre Angelo Collura | FIN |

Youth Women: 4.7

| | |
|---------------------------|--------------|
| Entries 117 | Countries 17 |
| 1st Anita Di Iasio | ITA |
| 2nd Tina Mihelic | CRO |
| 3rd Cansin Karga | TUR |
| 4th Vanessa le Bouteiller | FRA |
| 5th Clare Chapple | GBR |

2003 Cadiz, ESP**Open: Standard**

| | |
|-----------------------|--------------|
| Entries 174 | Countries 61 |
| 1st Gustavo Lima | POR |
| 2nd Robert Scheidt | BRA |
| 3rd Michael Blackburn | AUS |
| 4th Luis Martinez | ESP |
| 5th Daniel Birgmark | SWE |

2003 Riva del Garda, ITA**Men: Radial**

| | |
|----------------------|--------------|
| Entries 231 | Countries 31 |
| 1st Aron Lolic | CRO |
| 2nd Jake Bartrom | NZL |
| 3rd Karlo Krpeljevic | CRO |
| 4th Max Bulley | FRA |
| 5th Marc Jux | CHI |

Women: Radial

| | |
|-------------------------|--------------|
| Entries 50 | Countries 16 |
| 1st Katarzyna Szotynska | POL |
| 2nd Wioletta Wozniak | AUS |
| 3rd Jeanette Dagson | SWE |
| 4th Corinne Meyer | SUI |
| 5th Gea Juljens | NED |

Youth: Radial

| | |
|-----------------------|--------------|
| Entries 280 | Countries 27 |
| 1st Tonci Stipanovic | CRO |
| 2nd Tonko Kuzmanic | CRO |
| 3rd Jonasz Stelmazyk | POL |
| 4th Campbell Davidson | GBR |
| 5th Javier Padron | ESP |

2003 Cesme, TUR**Entries 98**

| | |
|-----------------------|--------------|
| Entries 98 | Countries 18 |
| Youth Men: 4.7 | |
| 1st Yuseferebasi | TUR |
| 2nd Ates Cinal | TUR |
| 3rd Mustafa Cakir | TUR |
| 4th Philip White | GBR |
| 5th Milosz Landowski | POL |

Youth Women: 4.7

| | |
|---------------------|--------------|
| Entries 31 | Countries 13 |
| 1st Ayda Unver | TUR |
| 2nd Anita Di Iasio | ITA |
| 3rd Didem Sarman | TUR |
| 4th Cansin Karga | TUR |
| 5th Istem Oguzbayir | TUR |

2002 Hynniss, USA**Open: Standard**

| | |
|--------------------|--------------|
| Entries 131 | Countries 44 |
| 1st Robert Scheidt | BRA |
| 2nd Karl Suneson | SWE |
| 3rd Paul Goodison | GBR |
| 4th Diego Negri | ITA |
| 5th Brendan Casey | AUS |

2002 Ontario, CAN**Men: Radial**

| | |
|----------------------|--------------|
| Entries 101 | Countries 19 |
| 1st Karlo Krpeljevic | CRO |
| 2nd Chris Ashley | USA |
| 3rd Tiago Rodrigues | BRA |
| 4th David Wright | CAN |
| 5th Jake Bartrom | NZL |

Women: Radial

| | |
|-------------------------|--------------|
| Entries 38 | Countries 10 |
| 1st Katarzyna Szotynski | POL |
| 2nd Miranda Powrie | NZL |
| 3rd Ciara Peelo | IRL |
| 4th Nicky Souter | AUS |
| 5th Alison Casey-Hall | AUS |

Youth: Radial

| | |
|--------------------|--------------|
| Entries 174 | Countries 20 |
| 1st Tonko Kuzmanic | CRO |
| 2nd Conner Higgins | CAN |
| 3rd Giles Scott | GBR |
| 4th Nick Thompson | GBR |
| 5th Max Guley | FRA |

2002 Muiderzand, NED

Entries 124 Countries 16

Youth Men: 4.7

| | |
|---------------------|-----|
| 1st Tonci Stanovic | CRO |
| 2nd Daniel Michelic | CRO |
| 3rd Colin Robard | NED |
| 4th Stefano Meciani | ITA |
| 5th Dennis Karpak | EST |

Youth Women: 4.7

| | |
|----------------------|-----|
| 1st Tugce Subasi | TUR |
| 2nd Celine Olivon | FRA |
| 3rd Mandy Mulder | NED |
| 4th Samantha Chidgey | AUS |
| 5th Lidia Loto | ITA |

2001 Cork, IRL

Open: Standard

| | |
|------------------------|--------------|
| Entries 159 | Countries 48 |
| 1st Robert Scheidt | BRA |
| 2nd Gustavo Lima | POR |
| 3rd Peer Moberg | NOR |
| 4th Paul Goodison | GBR |
| 5th Gareth Blankenberg | RSA |

2001 Vilanova, ESP

Men: Radial

| | |
|----------------------|--------------|
| Entries 230 | Countries 35 |
| 1st Michael Bullot | NZL |
| 2nd Andre Streppel | BRA |
| 3rd Aron Lohy | CRO |
| 4th Alp Alpogut | TUR |
| 5th Karlo Krceljovic | CRO |

Women: Radial

| | |
|--------------------------|--------------|
| Entries 56 | Countries 23 |
| 1st Katarzyna Szotynski | POL |
| 2nd Larissa Nevierov | ITA |
| 3rd Sara Lane Wright | BER |
| 4th Tatiana Drozdovskaya | BLR |
| 5th Jayne Singleton | GBR |

Youth: Radial

| | |
|-----------------------|--------------|
| Entries 260 | Countries 33 |
| 1st Michael Bullot | NZL |
| 2nd Iason Georgaris | GBR |
| 3rd Alexandre Monteau | FRA |
| 4th Mathieu Murati | FRA |
| 5th Guray Zimul | TUR |

2000 Cancun, MEX

Open: Standard

| | |
|-----------------------|--------------|
| Entries 141 | Countries 50 |
| 1st Robert Scheidt | BRA |
| 2nd Michael Blackburn | AUS |
| 3rd Ben Ainslie | GBR |
| 4th Karl Suneson | SWE |
| 5th Serge Kats | NED |

2000 Cesme, TUR

Men: Radial

| | |
|---------------------------|--------------|
| Entries 124 | Countries 25 |
| 1st Fredrik Lassenius | SWE |
| 2nd Alexandros Logothetis | GRE |
| 3rd Vangelis Chimonas | GRE |
| 4th Petar Cupac | CRO |
| 5th Kemal Muslubas | TUR |

Women: Radial

| | |
|-------------------------|--------------|
| Entries 33 | Countries 16 |
| 1st Katarzyna Szotynski | POL |
| 2nd Nicola Muller | GBR |
| 3rd Jayne Singleton | GBR |
| 4th Jeanette Dagson | SWE |
| 5th Denis Karacaoglu | TUR |

Youth: Radial

| | |
|-----------------------|--------------|
| Entries 137 | Countries 31 |
| 1st Gurray Zimul | TUR |
| 2nd Anders Nyholm | DEN |
| 3rd Arne Nieuwenhuys | NED |
| 4th Antonis Manolakis | GRE |
| 5th Andrew Walsh | GBR |

1999 Melbourne, AUS

Open: Standard

| | |
|-----------------------|--------------|
| Entries 141 | Countries 46 |
| 1st Ben Ainslie | GBR |
| 2nd Robert Scheidt | BRA |
| 3rd Karl Suneson | SWE |
| 4th Michael Blackburn | AUS |
| 5th Andrew Simpson | GBR |

1999 La Rochelle, FRA

Men: Radial

| | |
|-----------------------|--------------|
| Entries 167 | Countries 27 |
| 1st Adonis Bougiouris | GRE |
| 2nd Gustavo Lima | POR |
| 3rd Teddy Grestroy | FRA |
| 4th Luka Radelic | CRO |
| 5th Vagelis Chimonas | GRE |

Women: Radial

| | |
|----------------------------|--------------|
| Entries 42 | Countries 20 |
| 1st Kelly Hand | CAN |
| 2nd Jeanette Dagson | SWE |
| 3rd Helene Viazzo | FRA |
| 4th Clementine Destailleur | FRA |
| 5th Alison Casey | AUS |

Youth: Radial

| | |
|--------------------------|--------------|
| Entries 304 | Countries 35 |
| 1st Francisco Sanchez F. | ESP |
| 2nd Luka Radelic | CRO |
| 3rd Jorge Lima | POR |
| 4th Andrew Walsh | GBR |
| 5th Anders Nyholm | DEN |

1998 Mombasa, KEN

Men: Radial

| | |
|---------------------------|--------------|
| Entries 209 | Countries 25 |
| 1st Gustavo Lima | POR |
| 2nd Adonis Bougiouris | GRE |
| 3rd Alexandros Logothetis | GRE |
| 4th Raimondas Sluzdzinis | LTU |
| 5th Luka Radelic | CRO |

Women: Radial

| | |
|-------------------------|--------------|
| Entries 87 | Countries 19 |
| 1st Larissa Nevierov | ITA |
| 2nd Carolijn Brouwer | NED |
| 3rd Jeanette Dagson | SWE |
| 4th Marcelain de Koning | NED |
| 5th Jo Dikkenberg | AUS |

Youth: Radial

| | |
|----------------------|--------------|
| Entries 228 | Countries 33 |
| 1st Alastair Gair | NZL |
| 2nd Evagelos Himonas | GRE |
| 3rd Goncalo Lopes | POR |
| 4th Leigh McMillan | GBR |
| 5th David Hiver | GBR |

1997 Algarrobo, CHI

Open: Standard

| | |
|--------------------|--------------|
| Entries 128 | Countries 34 |
| 1st Robert Scheidt | BRA |
| 2nd Nik Burfoot | NZL |
| 3rd Ben Ainslie | GBR |
| 4th Hamish Pepper | NZL |
| 5th Hugh Styles | GBR |

1997 Mohamedia, MAR

Men: Radial

| | |
|--------------------------|--------------|
| Entries 122 | Countries 25 |
| 1st Raimondas Sluzdzinis | LTU |
| 2nd Romain Knipping | FRA |
| 3rd Selim Kakis | TUR |
| 4th Benoit Raphalen | FRA |
| 5th Goncalo Lopes | POR |

Women: Radial

| | |
|----------------------|--------------|
| Entries 40 | Countries 17 |
| 1st Sarah Blanck | AUS |
| 2nd Helen Waite | GBR |
| 3rd Anja Sahlberg | SWE |
| 4th Anje de Boer | NED |
| 5th Larissa Nevierov | ITA |

Youth: Radial

| | |
|-----------------------|--------------|
| Entries 122 | Countries 31 |
| 1st Teddy Grestroy | FRA |
| 2nd Romain Knipping | FRA |
| 3rd Alastair Gair | NZL |
| 4th Justin Dale | GBR |
| 5th Joao Santos Silva | POR |

1996 Cape Town, RSA

Open: Standard

| | |
|---------------------|--------------|
| Entries 134 | Countries 38 |
| 1st Robert Scheidt | BRA |
| 2nd Karl Suneson | SWE |
| 3rd Ben Ainslie | GBR |
| 4th Stefan Warkalla | GER |
| 5th Iain Percy | GBR |

Men: Radial

| | |
|--------------------------|--------------|
| Entries 96 | Countries 20 |
| 1st Brendan Casey | AUS |
| 2nd Andrew Kiriljuk | RUS |
| 3rd Allan Coutts | NZL |
| 4th Tim Shuwalow | AUS |
| 5th Dimitris Theodorakis | GRE |

Women: Radial

| | |
|----------------------|--------------|
| Entries 29 | Countries 11 |
| 1st Jacqueline Ellis | AUS |
| 2nd Larissa Nevierov | ITA |
| 3rd Kathryn McQueen | AUS |
| 4th Sarah Blanck | AUS |
| 5th Alison Casey | AUS |

1995 Tenerife, ESP

Open: Standard

| | |
|-----------------------|--------------|
| Entries 137 | Countries 39 |
| 1st Robert Scheidt | BRA |
| 2nd Nik Burfoot | NZL |
| 3rd Eivind Melbye | NOR |
| 4th Hamish Pepper | NZL |
| 5th Michael Blackburn | AUS |

Men: Radial

| | |
|-------------------|--------------|
| Entries 66 | Countries 18 |
| 1st Brendan Casey | AUS |
| 2nd Tim Shuwalow | AUS |
| 3rd Gustavo Lima | POR |
| 4th Sean Kirkjian | AUS |
| 5th David Huet | FRA |

Women: Radial

| | |
|----------------------|-------------|
| Entries 18 | Countries 8 |
| 1st Heidi Gordon | AUS |
| 2nd Larissa Nevierov | ITA |
| 3rd Roberta Hartley | GBR |
| 4th Alison Casey | AUS |
| 5th Roelien Huisman | NED |

1994 Wakayama, JPN

Open: Standard

| | |
|---------------------|--------------|
| Entries 120 | Countries 36 |
| 1st Nikolas Burfoot | NZL |
| 2nd Pascal Lacoste | FRA |
| 3rd Serge Kats | NED |
| 4th Hamish Pepper | NZL |
| 5th Peer Moberg | NOR |

Men: Radial

| | |
|----------------------|--------------|
| Entries 82 | Countries 14 |
| 1st Rui Pedro Coelho | POR |
| 2nd Rodion Luka | UKR |
| 3rd Nathan Handley | NZL |
| 4th Yanghe Zhu | CHN |
| 5th Todd Holzappel | AUS |

Women: Radial

| | |
|-------------------------|-------------|
| Entries 33 | Countries 8 |
| 1st Melanie Dennison | AUS |
| 2nd Jacqueline Ellis | AUS |
| 3rd Tracy Kirtley | SIN |
| 4th Ma. Bettina Marcone | ARG |
| 5th Elizabeth Roberts | AUS |

1993 Takapuna, NZL

Open: Standard

| | |
|----------------------|--------------|
| Entries 99 | Countries 29 |
| 1st Thomas Johanson | FIN |
| 2nd Peter Tanscheit | BRA |
| 3rd Robert Scheidt | BRA |
| 4th Nikolas Burfoot | NZL |
| 5th Michael Hestbaek | DEN |

Men: Radial

| | |
|-----------------------|--------------|
| Entries 102 | Countries 15 |
| 1st Ben Ainslie | GBR |
| 2nd Daniel Slater | NZL |
| 3rd Allan Coutts | NZL |
| 4th Michael Blackburn | AUS |
| 5th Peter Waring | NZL |

Women: Radial

| | |
|-----------------------|--------------|
| Entries 32 | Countries 12 |
| 1st Carolijn Brouwer | NED |
| 2nd Giselle Camet | USA |
| 3rd Alexandra Verbeek | NED |
| 4th Maria Vlachou | GRE |
| 5th Jacqueline Ellis | AUS |

1991 Porto Carras, GRE

Open: Standard

| | |
|-------------------------|--------------|
| Entries 105 | Countries 31 |
| 1st Peter Tanscheit | BRA |
| 2nd Stefan Warkalla | GER |
| 3rd Mladen Makjanic | CRO |
| 4th Michael Hestbaek | DEN |
| 5th Dimitri Theodorakis | GRE |

Men: Radial

| | |
|--------------------------|--------------|
| Entries 73 | Countries 15 |
| 1st Stewart Casey | AUS |
| 2nd Maria Vlachou | GRE |
| 3rd John Karageorgis | GRE |
| 4th Alessando Sartorelli | ITA |
| 5th Elias Katchorhis | GRE |

Women: Radial

| | |
|--------------------------|--------------|
| Entries 33 | Countries 10 |
| 1st Maria Vlachou | GRE |
| 2nd Carolijn Brouwer | NED |
| 3rd Ourania Flabouri | GRE |
| 4th Roberta Zucchinietti | ITA |
| 5th Marina Psychogios | GRE |

1990 Newport, USA

Open: Standard

| | |
|---------------------|--------------|
| Entries 103 | Countries 26 |
| 1st Glenn Bourke | AUS |
| 2nd Steven Bourdow | USA |
| 3rd Peter Tanscheit | BRA |
| 4th Mark Brink | USA |
| 5th Steve Rich | GBR |

Men: Radial

Entries 58 Countries 11

| | |
|----------------------|-----|
| 1st Peter Katcha | USA |
| 2nd John Bonds | USA |
| 3rd Scott Cheney | USA |
| 4th Ardis Bollweg | NED |
| 5th Ulrika Antonsson | SWE |

Women: Radial

Entries 30 Countries 11

| | |
|----------------------|-----|
| 1st Ardis Bollweg | NED |
| 2nd Ulrika Antonsson | SWE |
| 3rd Jacqueline Ellis | AUS |
| 4th Shona Moss | CAN |
| 5th Lotta Nilsson | SWE |

1989 Aarhus, DEN

Open: Standard

| | |
|-------------------------|--------------|
| Entries 104 | Countries 28 |
| 1st Glenn Bourke | AUS |
| 2nd Wouter Deutz | NED |
| 3rd Scott Ellis | AUS |
| 4th Francois Le Castrec | FRA |
| 5th Peter Tanscheit | BRA |

Men: Radial

| | |
|---------------------------|--------------|
| Entries 58 | Countries 17 |
| 1st James Johnstone | USA |
| 2nd Dimitrios Theodorakis | GRE |
| 3rd Jeff Loosemore | AUS |
| 4th Peter Katcha | USA |
| 5th Yuguan Xu | CHN |

Women: Radial

| | |
|----------------------|--------------|
| Entries 33 | Countries 15 |
| 1st Ardis Bollweg | NED |
| 2nd Giselle Camet | USA |
| 3rd Ulrika Antonsson | SWE |
| 4th Grethe Halvorsen | NOR |
| 5th Marie Dahloff | SWE |

1988 Falmouth, GBR

Open: Standard

| | |
|---------------------|--------------|
| Entries 88 | Countries 24 |
| 1st Glenn Bourke | AUS |
| 2nd Benny Anderson | DEN |
| 3rd Peter Fox | NZL |
| 4th Mark Brink | USA |
| 5th Stefan Warkalla | GER |

Women: Radial

| | |
|------------------------|--------------|
| Entries 31 | Countries 14 |
| 1st Jacqueline Ellis | AUS |
| 2nd Ardis Bollweg | NED |
| 3rd Ann Keates | GBR |
| 4th Ulrika Antonsson | SWE |
| 5th Johanna Harkonmaki | FIN |

Youth: Standard

| | |
|------------------------|--------------|
| Entries 62 | Countries 20 |
| 1st Ville Aalto Setälä | FIN |
| 2nd Joakim Berg | SWE |
| 3rd Jeroen Hardenwijk | NED |
| 4th Jon Lassenby | GBR |
| 5th Nikos Nikolsoudis | GRE |

1987 Melbourne, AUS

Open: Standard

| | |
|-----------------------|--------------|
| Entries 130 | Countries 20 |
| 1st Stuart Wallace | AUS |
| 2nd Gunni Pedersen | DEN |
| 3rd Peter Tanscheit | BRA |
| 4th Nelson Alencastro | BRA |
| 5th Simon Cole | GBR |

1987 Halmstad, SWE

Open: Standard

| | |
|----------------------|--------------|
| Entries 108 | Countries 28 |
| 1st Lawrence Crispin | GBR |
| 2nd Andreas John | GER |
| 3rd Benny Andersen | DEN |
| 4th Gustaf Svensson | SWE |
| 5th Stefan Warkalla | GER |

Women: Standard

| | |
|-----------------------|--------------|
| Entries 26 | Countries 12 |
| 1st Marit Soderstrom | SWE |
| 2nd Lynne Jewell | USA |
| 3rd Francesca Pavesi | ITA |
| 4th Susanne Madsen | DEN |
| 5th Claudine Tatbouet | FRA |

1983 Guldnef, USA

Open: Standard

| | |
|----------------------|--------------|
| Entries 145 | Countries 27 |
| 1st Oscar Paulich | NED |
| 2nd Per Arne Nilson | NOR |
| 3rd Asbjorn Amkvaern | SWE |
| 4th Roland Gaebler | GER |
| 5th John Irvine | NZL |

Women: Standard

| | |
|--------------------|-------------|
| Entries 12 | Countries 5 |
| 1st Betsy Jenewitt | USA |
| 2nd Lynne Jewell | USA |
| 3rd Carole Spooner | CAN |
| 4th Virginia Perry | USA |
| 5th Susanne Madsen | DEN |

1982 Sardinia, ITA

Open: Standard
Entries 231 Countries 28

| | |
|-------------------|-----|
| 1st Terry Neilson | CAN |
| 2nd Andrew Roy | CAN |
| 3rd Mark Brink | USA |
| 4th Peter Vilby | DEN |
| 5th John Irvine | NZL |

Women: Standard

Entries 23

| | |
|----------------------|-----|
| 1st Marion Steenhuis | NED |
| 2nd Vittoria Masotto | ITA |
| 3rd Francesca Pavesi | ITA |
| 4th Susanne Schmidt | GER |
| 5th Barbara Champion | GBR |

1980 Kingston, CAN

Open: Standard
Entries 350 Countries 25

| | |
|----------------------|-----|
| 1st Ed Baird | USA |
| 2nd Jose Barcel Dias | BRA |
| 3rd John Currier | NZL |
| 4th Sjaak Haakman | NED |
| 5th Duncan Lewis | CAN |

Women: Standard

Entries: 20

| | |
|-----------------------|-----|
| 1st Marit Soderstrom | SWE |
| 2nd Lynne Jewell | USA |
| 3rd Cheryl Smith | NZL |
| 4th Annette Henderson | CAN |
| 5th Kathy Karlson | USA |

1979 Perth, AUS

Open: Standard
Entries 93 Countries 25

| | |
|---------------------|-----|
| 1st Lasse Hjortnaes | DEN |
| 2nd Peter Conde | AUS |
| 3rd Andrew Menkart | USA |
| 4th Cor Van Ankerk | NED |
| 5th David Perry | USA |

1977 Cabo Frio, BRA

Open: Standard
Entries 104 Countries 23

| | |
|--------------------|-----|
| 1st John Bertrand | USA |
| 2nd Peter Commette | USA |
| 3rd Mark Neeleman | NED |
| 4th Tim Alexander | AUS |
| 5th Gary Knapp | USA |

1976 Kiel, GER

Open: Standard
Entries 77 Countries 24

| | |
|--------------------|-----|
| 1st John Bertrand | USA |
| 2nd Barry Thom | NZL |
| 3rd Edward Adams | USA |
| 4th Jeff Madrigali | USA |
| 5th Emile Pels | NED |

1974 Bermuda

Open: Standard
Entries 108 Countries 24

| | |
|--------------------|-----|
| 1st Peter Commette | USA |
| 2nd Norm Freeman | USA |
| 3rd Chris Boome | USA |
| 4th Hugo Schmidt | USA |
| 5th Carl Buchan | USA |

MASTERS WORLD CHAMPIONSHIPS**2025 Formia, ITA**

ILCA 7
Entries 193 Countries 29

Apprentices

| | |
|------------------------|-----|
| 1st Matej Valic | SLO |
| 2nd Wannus Van Laer | BEL |
| 3rd Andres Heredia | ARG |
| 4th Scott Sydney | AUS |
| 5th Mihalios Koulianos | GRE |

Masters

| | |
|----------------------------------|-----|
| 1st Bruno Fontes | BRA |
| 2nd Aronzo Bougiouris | GRE |
| 3rd Alessandro Sartorelli | ITA |
| 4th Aristoteles Chatzistamatouli | GRE |
| 5th Viktor Karlsson | SWE |

Grand Masters

| | |
|-----------------------|-----|
| 1st Brett Beyer | AUS |
| 2nd Rik Wolters | NED |
| 3rd Christoph Marsano | AUT |
| 4th David Hiebert | USA |
| 5th Antoni Roig | ESP |

Great Grand Masters

| | |
|-----------------------|-----|
| 1st Jose Luis Doreste | ESP |
| 2nd Mark Bear | USA |
| 3rd Michael Hicks | GBR |
| 4th Chris Rodowicz | AUS |
| 5th Roberto Bini Bini | ITA |

ILCA 6

Entries 252 Countries 31

Apprentices

| | |
|----------------------|-----|
| 1st Albert Rudawski | POL |
| 2nd Lucia Reyes | ESP |
| 3rd Isaac Bussin | CAN |
| 4th Alexis Tourneur | FRA |
| 5th Giovanni Gallego | ITA |

Women Apprentices

| | |
|--------------------------|-----|
| 1st Lucia Reyes | ESP |
| 2nd Miriam Charles Tolra | ESP |
| 3rd Hanne Jansch | GER |
| 4th Anja Weick | GER |
| 5th Eva Deichmann | GER |

Masters

| | |
|-----------------------|-----|
| 1st Jon Emmett | GBR |
| 2nd Alberto Giacalone | TUR |
| 3rd Roberto Giacalone | ITA |
| 4th Elisa Boschin | ITA |
| 5th Piero Vigo | ITA |

Women Masters

| | |
|---------------------------|-----|
| 1st Elisa Boschin | ITA |
| 2nd Beatriz Fontius | GER |
| 3rd Marina Sánchez Ferrer | ESP |
| 4th Deniz Cirivello | USA |
| 5th Ulrike Heck | GER |

Grand Masters

| | |
|----------------------|-----|
| 1st Carlos Martinez | ESP |
| 2nd Anders Mattsson | SWE |
| 3rd Keith Davids | USA |
| 4th Alessio Gannelli | ITA |
| 5th Xavier Boluda | ESP |

Women Grand Masters

| | |
|----------------------|-----|
| 1st Christine Bridge | AUS |
| 2nd Silvia Ravellat | ESP |
| 3rd Diane Sissingh | AUS |
| 4th Paola Porta | ITA |
| 5th Michelle Lefevre | AUS |

Great Grand Masters

| | |
|-----------------------|-----|
| 1st Gilles Coadou | FRA |
| 2nd James Mitchell | AUS |
| 3rd Mike Schmidt | USA |
| 4th Luis André Castro | BRA |
| 5th Timothy Woodford | CAN |

Women Great Grand Masters

| | |
|------------------------|-----|
| 1st Lyndall Patterson | AUS |
| 2nd Lesley Reichenfeld | CAN |
| 3rd Ann Loren | SWE |
| 4th Evelyn Ferrat | FRA |
| 5th Isabelle Arnoux | FRA |

Legends (75+)

| | |
|----------------------|-----|
| 1st Robert Lowndes | AUS |
| 2nd William Symes | USA |
| 3rd Miguel Alvarez | ESP |
| 4th Tim Alexander | AUS |
| 5th Peter Seidenberg | USA |

2024 Adelaide, AUS

ILCA 7
Entries 85 Countries 13

Apprentices

| | |
|------------------------|-----|
| 1st Luke Deegan | NZL |
| 2nd Colin Leonard | IRL |
| 3rd Lorenzo Cerretelli | ITA |
| 4th Francesco Bottoni | ITA |
| 5th Ian Elliott | SWE |

Masters

| | |
|-----------------------|-----|
| 1st Brendan Casey | AUS |
| 2nd David Whait | AUS |
| 3rd Scott Leith | NZL |
| 4th Christoph Bottoni | AUS |
| 5th Andrew Robinson | AUS |

Grand Masters

| | |
|-----------------------|-----|
| 1st Brett Beyer | AUS |
| 2nd Andrew Dellabarca | NZL |
| 3rd Mark Lyttle | GBR |
| 4th Christoph Marsano | AUT |
| 5th Andrew Stransky | AUS |

Great Grand Masters

| | |
|---------------------|-----|
| 1st Steve Gunther | AUS |
| 2nd Tim Law | GBR |
| 3rd Michael Wilson | AUS |
| 4th Nick Page | NZL |
| 5th Emilio Castelli | USA |

ILCA 6

Entries 137 Countries 17

Apprentices

| | |
|---------------------------|-----|
| 1st Franco Riquelme | ARG |
| 2nd Svenja Weger | GER |
| 3rd Adil Khalid | UAE |
| 4th Vaimoia Astrid Ripley | SAM |
| 5th Wing Ho Kwan | HKG |

Women Apprentices

| | |
|---------------------------|-----|
| 1st Svenja Weger | GER |
| 2nd Vaimoia Astrid Ripley | SAM |
| 3rd Samantha Homan | AUS |
| 4th Gabrielle Nagy | FRA |

Masters

| | |
|-------------------|-----|
| 1st Simon Small | AUS |
| 2nd Phil Wild | NZL |
| 3rd Jon Emmett | GBR |
| 4th Daniel Blight | AUS |
| 5th Andrew Darcey | AUS |

Women Masters

| | |
|-----------------------|-----|
| 1st Alexandra Behrens | GER |
| 2nd Tiff Evans | AUS |
| 1st Andrew Holdsworth | USA |
| 2nd Mark Tonner-Joyce | USA |
| 3rd Bruce Savage | AUS |
| 4th Allan Clark | CAN |
| 5th Al Sargent | USA |

Women Grand Masters

| | |
|----------------------|-----|
| 1st Christine Bridge | AUS |
| 2nd Kerrie Shimeld | AUS |
| 3rd Diane Sissingh | AUS |
| 4th Daniela Siepmann | GER |
| 5th Michelle Lefevre | AUS |

Great Grand Masters

| | |
|------------------------|-----|
| 1st James Mitchell | AUS |
| 2nd Terry Scutcher | GBR |
| 3rd Richard Longbottom | AUS |
| 4th Jeff Loosemore | AUS |
| 5th Tony Mchphail | AUS |

Women Great Grand Masters

| | |
|-----------------------|-----|
| 1st Lyndall Patterson | AUS |
| 2nd Vanessa Dudley | AUS |

Legends (75+)

| | |
|---------------------|-----|
| 1st Bill Symes | USA |
| 2nd Tim Alexander | AUS |
| 3rd Robert Lowndes | AUS |
| 4th Jonathan Andron | USA |
| 5th Jacques Kerrest | USA |

2023 Pattaya, THA

ILCA 7
Entries 86 Countries 22

Apprentices

| | |
|---------------------|-----|
| 1st Keerati Bualong | THA |
| 2nd Adil Khalid | UAE |
| 3rd Pietro Corbucci | ITA |
| 4th Kovacs Zoltan | HUN |
| 5th Balazs Vincze | HUN |

Masters

| | |
|-----------------------|-----|
| 1st Adonis Bougiouris | GRE |
| 2nd Christoph Bottoni | AUS |
| 3rd Peter Hurley | USA |
| 4th Kunihiro Otsuka | JPN |
| 5th Ilias Kovatzis | GRE |

Grand Masters

| | |
|-----------------------|-----|
| 1st Brett Beyer | AUS |
| 2nd Jan Scholten | AUS |
| 3rd Andrew Holdsworth | USA |
| 4th Gavin Dagley | AUS |
| 5th Christoph Marsano | AUT |

Great Grand Masters

| | |
|---------------------|-----|
| 1st Tim Law | GBR |
| 2nd Stephen Gunther | AUS |
| 3rd Jeff Loosemore | AUS |
| 4th Colin Dibb | AUS |
| 5th Michael Hicks | GBR |

ILCA 6

Entries 117 Countries 24

Apprentices

| | |
|--------------------------|-----|
| 1st Viktorija Andriulyte | LTU |
| 2nd Bo Jeong | KOR |
| 3rd Adil Khalid | UAE |
| 4th Isaac Bussin | CAN |
| 5th Elliot Scali | AUS |

Women Apprentices

| | |
|--------------------------|-----|
| 1st Viktorija Andriulyte | LTU |
| 2nd Kaoru Arai Awano | JPN |
| 3rd Caria Canturri | AND |
| 4th Liang Fion Yinyi | SGP |

Masters

| | |
|-------------------------|-----|
| 1st Jon Emmett | GBR |
| 2nd Ian Gregory | GBR |
| 3rd Fabio Suyama Ramos | BRA |
| 4th Alexander Montanari | ITA |
| 5th Al Sargent | USA |

Women Masters

| | |
|-----------------------------------|-----|
| 1st Alexandra Behrens | GER |
| 2nd Naoko Kemmoku | JPN |
| 3rd Rotjana "Apple" Asawatanaporn | THA |
| 4th Rika Nishino | JPN |

Grand Masters

| | |
|-----------------------|-----|
| 1st Allan Clark | CAN |
| 2nd Terry Scutcher | GBR |
| 3rd David White | AUS |
| 4th Andrew Holdsworth | USA |
| 5th Ulf Myrin | SWE |

Women Grand Masters

| | |
|----------------------|-----|
| 1st Monica Wilson | USA |
| 2nd Diane Sissingh | AUS |
| 3rd Ann Loren | SWE |
| 4th Michelle Lefevre | AUS |
| 5th Pru Bennett | AUS |

Great Grand Masters

| | |
|-----------------------|-----|
| 1st Jeff Loosemore | AUS |
| 2nd Lyndall Patterson | AUS |
| 3rd Stephen Gunther | AUS |
| 4th Martin White | AUS |
| 5th Bruce Martinson | USA |

Women Grand Masters

| | |
|-----------------------|-----|
| 1st Lyndall Patterson | AUS |
|-----------------------|-----|

Legends (75+)

| | |
|----------------------|-----|
| 1st Bill Symes | USA |
| 2nd Jonathan Andron | USA |
| 3rd Shigeo Kato | JPN |
| 4th Jacques Kerrest | USA |
| 5th Peter Seidenberg | USA |

2022 Riviera Nayarit, MEX

ILCA 7
Entries 64 Countries 14

Apprentices

| | |
|----------------------------|-----|
| 1st Andres Heredia | ARG |
| 2nd Charles Baillie Strong | LUX |
| 3rd Adil Khalid | UAE |
| 4th Antonios Kondis | GRE |
| 5th James Bauley | USA |

Masters

| | |
|-----------------------|-----|
| 1st Adonis Bougiouris | GRE |
| 2nd Ernesto Rodriguez | USA |
| 3rd Orlando Gledhill | GBR |
| 4th Ray Davies | CAN |
| 5th Peter Hurley | USA |

Grand Masters

| | |
|-------------------------------------|-----|
| 1st Brett Beyer | AUS |
| 2nd Mark Lyttle | GBR |
| 3rd Andrew Roy | CAN |
| 4th Jose Maria Van Der Ploeg Garcia | ESP |

Great Grand Masters

| | |
|--------------------|-----|
| 1st Tim Law | GBR |
| 2nd Wolfgang Gerz | GER |
| 3rd Peter Vessella | USA |
| 4th Vann Wilson | USA |
| 5th Michael Hicks | GBR |

ILCA 6

Entries 77 Countries 14

Apprentices

| | |
|----------------------------------|-----|
| 1st Jon Emmett | GBR |
| 2nd Antonios Kondis | GRE |
| 3rd Tania Elias Calles Wolf | MEX |
| 4th Carlos Edmundo Silva Galicia | MEX |
| 5th David Waitting | USA |

Women Apprentices

| | |
|-----------------------------|-----|
| 1st Tania Elias Calles Wolf | MEX |
| 2nd Georgia Chिमونا | GRE |
| 3rd Natalie Burls | USA |
| 4th Christine Potts | USA |

Masters

| | |
|--------------------|-----|
| 1st Ian Gregory | GBR |
| 2nd Niall Peelo | IRL |
| 3rd Robert Jackson | CAY |
| 4th Sumet Patel | USA |
| 5th David Goddard | GBR |

| | |
|------------------------------|-----|
| Women Masters | |
| 1st Alexandra Behrens | GER |
| 2nd Dorian Haldean | USA |
| Grand Masters | |
| 1st Allan Clark | CAN |
| 2nd David Luketina | AUS |
| 3rd Eduardo Santambrogio | ARG |
| 4th Andrew Holdsworth | GBR |
| 5th Terry Scutcher | GBR |
| Women Grand Masters | |
| 1st Judith Krinski | USA |
| Great Grand Masters | |
| 1st Jeff Loosemore | AUS |
| 2nd Miguel Nogueur Castellvi | ESP |
| 3rd Walt Spevak | USA |
| 4th Bruce Martinson | USA |
| 5th Robert Koci | CAN |
| Legends (75+) | |
| 1st Chris Boome | USA |
| 2nd Bill Symes | USA |
| 3rd Jonathan Andron | USA |
| 4th Jacques Kerrest | USA |
| 5th Peter Seidenberg | USA |

2021 Barcelona, ESP
Entries 239 Countries 29
ILCA 7

| | |
|----------------------------|---------------------------|
| Apprentices | |
| 1st Wannas Van Laer | BEL |
| 2nd Maciej Grabowski | POL |
| 3rd Lorenzo Cerretelli | ITA |
| 4th Ian Elliott | CAN |
| 5th George Kingston | IRL |
| Masters | |
| 1st Ernesto Rodriguez | USA |
| 2nd Peter Hurley | USA |
| 3rd Bertrand Blanchet | FRA |
| 4th Roger Schult | GER |
| 5th Lorenzo Migliaccio | ITA |
| Grand Masters | |
| 1st Robert Hallawell | USA |
| 2nd Alejandro Cloos | ARG |
| 3rd Jose Maria | van der Ploeg Garcia, ESP |
| 4th Allan Clark | CAN |
| 5th Benoit Meesmaecker | FRA |
| Great Grand Masters | |
| 1st Jose Luis Doreste | ESP |
| 2nd Wolfgang Gerz | GER |
| 3rd Tim Law | GBR |
| 4th Alan Keen | RSA |
| 5th Michael Hicks | GBR |

| | |
|----------------------------------|-----|
| ILCA 6 | |
| Apprentices | |
| 1st Jon Emmett | GBR |
| 2nd Arturo Reina | ESP |
| 3rd David Gonzalez | ESP |
| 4th Carlos Edmundo | |
| 5th Silva Galicia | MEX |
| 6th Javier Isidro Tejedor | ESP |
| Women Apprentices | |
| 1st Marina Sánchez Ferrer | ESP |
| 2nd Elisa Boschini | ITA |
| 3rd Robyn Sadler | RSA |
| Masters | |
| 1st Stefan Eriksson | SWE |
| 2nd Jean-Christophe Leydet | FRA |
| 3rd Monica Azon | ESP |
| 4th Alessio Marinelli | ITA |
| 5th Anders Mattsson | SWE |
| Women Masters | |
| 1st Monica Azon | ESP |
| 2nd Giovanna Lenci | ITA |
| 3rd Elena Saez De Juan | ESP |
| 4th Isabelle Auffret | FRA |
| Grand Masters | |
| 1st Gilles Coadou | FRA |
| 2nd Miguel Nogueur Castellvi | ESP |
| 3rd Pieter Van Laer | BEL |
| 4th Sean Craig | SWE |
| 5th Ulf Myring | SWE |
| Women Grand Masters | |
| 1st Helene Viazzo | FRA |
| 2nd Helene Viazzo | FRA |
| 3rd Silvia Ravellat | ESP |
| 4th Silvia Ravellat | FRA |
| 5th Ann Loren | SWE |
| Great Grand Masters | |
| 1st Bill Symes | USA |
| 2nd Paul Clifford | CAN |
| 3rd John Reay | GBR |
| 4th Bruce Martinson | USA |
| 5th Miguel Alvarez | ESP |
| Women Great Grand Masters | |
| 1st Evelyn Ferrat | FRA |
| Legends (75+) | |
| 1st Peter Seidenberg | USA |
| 2nd Jacques Kerrest | USA |
| 3rd Henk Wittenberg | NED |
| 4th Ian Rawet | GBR |
| 5th Poopy Marcon | FRA |

| | |
|---------------------------------|-----|
| 2019 Port Zélande, NED | |
| Entries 305 Countries 27 | |
| Standard | |
| Apprentices | |
| 1st Dave Ridley | NZL |
| 2nd Eduardo Van Vianen | NED |
| 3rd Jared West | ESP |
| 4th Michiel Peeters | NED |
| 5th Gordon Welsh | CAN |
| Masters | |
| 1st Serge Kats | NED |
| 2nd Brett Beyer | AUS |
| 3rd Adis Bougiouris | GRE |
| 4th Christopher Marsano | AUT |
| 5th Stuart Hudson | GBR |
| Grand Masters | |
| 1st Carlos Martinez | ESP |
| 2nd Stefan Nordström | SWE |
| 3rd Rik Wolters | NED |
| 4th Tomas Nordqvist | SWE |
| 5th Per Arne Nilsen | NOR |
| Great Grand Masters | |
| 1st Wolfgang Gerz | GER |
| 2nd Peter Sherwin | GBR |
| 3rd Michael Hicks | GBR |
| 4th Don Hall | USA |
| 5th John Roberson | AUS |

| | |
|----------------------------|------------------|
| Radial | |
| Apprentices | |
| 1st Jon Emmett | GBR |
| 2nd Georgia Chिमونا | GRE |
| 3rd Javier Tejedor | ESP |
| 4th Tulloch Priest | GBR |
| 5th Nathalie Gunst | BEL |
| Women Apprentices | |
| 1st Georgia Chिमونا | GRE |
| 2nd Nathalie Gunst | BE |
| 3rd Pernilla Ekelund | SWE |
| 4th Annemarie van Nes | NED |
| 5th Anastasiya Kalinina | RUS |
| Masters | |
| 1st Scott Leith | NZL |
| 2nd Anders Mattsson | SWE |
| 3rd Leydet Jean-Christophe | FRA |
| 4th Peppu Marinelli | ITA |
| 5th Ian Jones | GBR |
| Women Masters | |
| 1st Giovanna Lenci | ITA |
| 2nd Zilla Fokke | NED |
| 3rd Martine Polderman | van Leeuwen, NED |
| 4th Caroline Berghuis | NED |
| 5th Annemieke Beemster | NED |
| Grand Masters | |
| 1st Gilles Coadou | FRA |
| 2nd Kim Tan | NED |
| 3rd Timothy Woodford | CAN |
| 4th Wilmar Groenendijk | NED |
| 5th Martin van Olfen | NED |

| | |
|----------------------------------|-----|
| Women Grand Masters | |
| 1st Vanessa Dudley | AUS |
| 2nd Lyndall Patterson | AUS |
| 3rd Camilla Graves | AUS |
| 4th Martien Zeegers-Nouwen | NED |
| 5th Ann Loren | SWE |
| Great Grand Masters | |
| 1st Jeff Loosemore | AUS |
| 2nd Bill Symes | USA |
| 3rd Henk Wittenberg | NED |
| 4th Jaap Mazereeuw | NED |
| 5th Robert Lowndes | AUS |
| Women Great Grand Masters | |
| 1st Hilary Thomas | GBR |
| Legends (75+) | |
| 1st Kerry Waraker | AUS |
| 2nd Johan van Rossem | CAN |
| 3rd Kevin Phillips | AUS |
| 4th Peter Seidenberg | USA |
| 5th Steve Avery | USA |

| | |
|---------------------------------|-----|
| 2018 Dún Laoghaire, IRL | |
| Entries 302 Countries 25 | |
| Standard | |
| Apprentices | |
| 1st Leandro Rosado | ESP |
| 2nd Gord Welsh | CAN |
| 3rd Roger O'Gorman | IRL |
| 4th David Quinn | IRL |
| 5th Pete Smyth | IRL |
| Masters | |
| 1st Brett Beyer | AUS |
| 2nd Niklas Edler | SWE |
| 3rd David Whait | CAN |
| 4th Orlando Gedhlich | GBR |
| 5th Peter Hurley | USA |
| Grand Masters | |
| 1st Mark Lyttle | GBR |
| 2nd Carlos Martinez | ESP |
| 3rd Arnoud Hummel | NED |
| 4th Gavin Dagley | AUS |
| 5th Tomas Nordqvist | SWE |

| | |
|----------------------------------|-----|
| Great Grand Masters | |
| 1st Wolfgang Gerz | GER |
| 2nd Michael Hicks | GBR |
| 3rd Charles Campion | GBR |
| 4th Alan Keen | RSA |
| 5th Mark Bethwaite | AUS |
| Radial | |
| Apprentices | |
| 1st Ben Elvin | GBR |
| 2nd Thomas Chaix | IRL |
| 3rd Andrew Byrne | GBR |
| 4th Niall Pheo | GBR |
| 5th Darrell Reamsbottom | IRL |
| Women Apprentices | |
| 1st Alison Stevens | GBR |
| Masters | |
| 1st Scott Leith | NZL |
| 2nd Ian Jones | GBR |
| 3rd Robert Hallawell | USA |
| 4th Andrew Holdsworth | USA |
| 5th Fredrik Wallander | SWE |
| Women Masters | |
| 1st Caroline Muselet | CAN |
| 2nd Giovanna Lenci | ITA |
| 3rd Alexandra Weirrauch | GER |
| 4th Dirma Eilsenga | NED |
| 5th Shirley Gilmore | IRL |
| Grand Masters | |
| 1st Stephen Cockerill | GBR |
| 2nd Gustaf Svensson | SWE |
| 3rd Timothy Woodford | CAN |
| 4th James Mitchell | AUS |
| 5th Robert Britten | CAN |
| Women Grand Masters | |
| 1st Lyndall Patterson | AUS |
| 2nd Camilla Graves | AUS |
| 3rd Claudine Talibouet | FRA |
| 4th Sue Ritchie | GBR |
| 5th Ute Reichenfeld | CAN |
| Great Grand Masters | |
| 1st Bill Symes | USA |
| 2nd Lasse Westesson | SWE |
| 3rd Christopher Boyd | SUI |
| 4th Jean-Luc Dreyer | IRL |
| 5th Lorenz Müller | SUI |
| Women Great Grand Masters | |
| 1st Hilary Thomas | GBR |
| Legends (75+) | |
| 1st Peter Seidenberg | USA |
| 2nd Lindsay Hewitt | USA |
| 3rd David Wylie | AUS |
| 4th Steve Avery | USA |
| 5th Jay Winberg | USA |
| Women Legends (75+) | |
| 1st Deirdre Webster | CAN |

| | |
|---------------------------------|-----|
| 2017 Split, CRO | |
| Entries 349 Countries 35 | |
| Standard | |
| Apprentices | |
| 1st Maciej Grabowski | POL |
| 2nd Maxim Semerkh | RUS |
| 3rd Adonis Bougiouris | GRE |
| 4th Guilherme Roth | BRA |
| 5th Girls Fisers-Blu | LAT |
| Masters | |
| 1st Brett Beyer | AUS |
| 2nd Peter Hurley | USA |
| 3rd Ernesto Rodrigo | USA |
| 4th Niklas Edler | SWE |
| 5th Chr. Gunni Pede | DEN |
| Grand Masters | |
| 1st Allan Clark | CAN |
| 2nd Andy Roy | CAN |
| 3rd Tomas Nordqvist | SWE |
| 4th Tim Law | GBR |
| 4th Nick Harrison | GBR |
| 4th Peter Vessella | USA |
| 5th Wolfgang Gerz | GER |
| Great Grand Masters | |
| 1st Michael Nissen | GER |
| 2nd Mark Bethwaite | AUS |
| 3rd John Pitman | NZL |
| 4th Alan Keen | RSA |
| 5th Doug Peckover | USA |
| Radial | |
| Apprentices | |
| 1st Jon Emmett | GBR |
| 2nd Anastasiya Chernova | RUS |
| 3rd Noel Bayard | FRA |
| 4th David Waiting | RSA |
| 5th Georgia Chिमونا | GRE |
| Women Apprentices | |
| 1st Anastasiya Chernova | RUS |
| 2nd Georgia Chिमونا | GRE |
| 3rd Paula Marino | URU |
| 4th Alice Virginia Grassi | ITA |
| 5th Pernilla Ekelund | USA |

| | |
|----------------------------------|-----|
| Masters | |
| 1st Alessio Marinelli | ITA |
| 2nd Scott Leith | NZL |
| 3rd Wilmar Groenendijk | NED |
| 4th Leydet Jean-Christophe | FRA |
| 5th Edmund Tam | NZL |
| Women Masters | |
| 1st Giovanna Lenci | ITA |
| 2nd Michelle Bain | NZL |
| 3rd Monica Wilson | USA |
| 4th Kimber Couranz | USA |
| 5th Alexandra Weirrauch | GER |
| Grand Masters | |
| 1st Martin White | AUS |
| 2nd Pierantonio Masotto | ITA |
| 3rd Terry Scutcher | GBR |
| 4th Rob Cage | GBR |
| 5th Jeff Loosemore | AUS |
| Women Grand Masters | |
| 1st Lyndall Patterson | AUS |
| 2nd Vanessa Dudley | AUS |
| 3rd Ann Loren | SWE |
| 4th Lesley Hotchin | GBR |
| 5th Ute Reichenfeld | GER |
| Great Grand Masters | |
| 1st Bill Symes | USA |
| 2nd Robert Lowndes | AUS |
| 3rd Kerry Waraker | AUS |
| 4th Peter Seidenberg | USA |
| 5th Peter Heywood | AUS |
| 6th Michael Kinnear | GBR |
| Women Great Grand Masters | |
| 1st Hilary Thomas | GBR |
| 2nd Gill Waiting | NZL |
| 3rd Deirdre Webster | CAN |
| Over 75 Masters | |
| 1st Kerry Waraker | AUS |
| 2nd Peter Seidenberg | USA |
| 3rd Steve Avery | USA |
| 4th Roger Williams | GBR |
| 5th Claude Tiger | FRA |

| | |
|---------------------------------|-----|
| 2016 Nuevo Vallarta, MEX | |
| Entries 227 Countries 23 | |
| Standard | |
| Apprentices | |
| 1st Pablo Rabago | MEX |
| 2nd Guilherme Roth | BRA |
| 3rd Alejandro Rabago | MEX |
| 4th Alfonso Aguilar | MEX |
| 5th Fabian Gomez-Ibarra | MEX |
| Masters | |
| 1st Brett Beyer | AUS |
| 2nd Ernesto Rodriguez | USA |
| 3rd Andrew Dellabarca | NZL |
| 4th Benoit Meesmaecker | FRA |
| 5th Peter Hurley | USA |
| Grand Masters | |
| 1st Gavin Dagley | AUS |
| 2nd Cristian Herman | CHI |
| 3rd Allan Clark | CAN |
| 4th Tim Law | GBR |
| 5th Steve Gunther | AUS |
| Great Grand Masters | |
| 1st Mark Bethwaite | AUS |
| 2nd Doug Peckover | USA |
| 3rd James Temple | AUS |
| 4th Alberto Larrea | ARG |
| 5th John Roberson | AUS |
| Radial | |
| Apprentices | |
| 1st Scott Leith | NZL |
| 2nd Jon Emmett | GBR |
| 3rd Ian Gregory | GBR |
| 4th Alejandro Rabago | MEX |
| 5th Fabio Suyama Ramos | BRA |
| Women Apprentices | |
| 1st Natalya Goncharova | USA |
| Masters | |
| 1st Carlos Eduardo Wanderley | BRA |
| 2nd Richard Blakey | NZL |
| 3rd Alessio Marinelli | ITA |
| 4th Keith Davids | USA |
| 5th Edmund Tam | NZL |
| Women Masters | |
| 1st Marcia Macdonald | BRA |
| 2nd Agneta Jonsson | SWE |
| 3rd Diane Sissingh | AUS |
| 4th Alexandra Weirrauch | GER |
| 5th Julie Hughes | CAN |
| Grand Masters | |
| 1st Vanessa Dudley | AUS |
| 2nd Jeff Loosemore | AUS |
| 3rd Luis Castillo | BRA |
| 4th Terry Scutcher | GBR |
| 5th Robert Britten | CAN |
| Women Grand Masters | |
| 1st Vanessa Dudley | AUS |
| 2nd Lyndall Patterson | AUS |
| 3rd Kathy Luciano | USA |

| | |
|----------------------------------|-----|
| Great Grand Masters | |
| 1st Robert Lowndes | AUS |
| 2nd William Symes | USA |
| 3rd Michael Kinnear | GBR |
| 4th Jon Andron | USA |
| 5th Kevin Phillips | USA |
| Women Great Grand Masters | |
| 1st Hilary Thomas | GBR |
| Over 75 Masters | |
| 1st Peter Seidenberg | USA |
| 2nd Kerry Waraker | USA |
| 3rd David Hartman | CAN |
| 4th Geoffrey Lucas | AUS |
| 5th Denis O'Sullivan | IRL |

2015 Kingdon, CAN
Entries 247 Countries 25
Standard

| | |
|-----------------------|-----|
| Apprentices | |
| 1st Adonis Bougiouris | GRE |
| 2nd Matt Blakey | NZL |
| 3rd Paul Scullion | GBR |
| 4th Denzil May | GBR |
| 5th Ray Davies | CAN |
| 1st | |
| 1st Brett Beyer | AUS |
| 2nd Peter Hurler | USA |
| 3rd Ari Barshi | DOM |
| 4th Marc Jacobi | USA |
| 5th Brad Taylor | AUS |
| Grand Masters | |
| 1st Peter Shope | USA |
| 2nd Andy Roy | CAN |
| 3rd Mark Bear | USA |
| 4th Yann Wilson | USA |
| 5th Gavin Dagley | AUS |

| | |
|----------------------------------|-----|
| Great Grand Masters | |
| 1st Mark Bethwaite | AUS |
| 2nd Alan Keen | GBR |
| 3rd Robert Blakey | NZL |
| 4th David Frazier | USA |
| 5th John Roberson | AUS |
| Radial | |
| Apprentices | |
| 1st Scott Leith | NZL |
| 2nd Zac Skulander | AUS |
| 3rd Steven Smith | GBR |
| 4th Pierre-Olivier Roy | CAN |
| 5th Duncan Whitrow | GBR |
| Women Apprentices | |
| 1st Erika Vines | CAN |
| 2nd Alexandra Wehrauch | GER |
| 3rd Dorian Heigman | USA |
| 4th Jennifer Ruddy | USA |
| Masters | |
| 1st Keith Davids | USA |
| 2nd Ian Jones | GBR |
| 3rd Joao Ramos | BRA |
| 4th Michael Knowsley | NZL |
| 5th Nigel Heath | CAN |
| Women Masters | |
| 1st Kimberly Couranz | USA |
| 2nd Margaret Podlich | USA |
| 3rd Monica Wilson | CAN |
| 4th Julie Stewart | USA |
| 5th Lisa Pelling | CAN |
| Grand Masters | |
| 1st Allan Clark | CAN |
| 2nd Terry Scutcher | GBR |
| 3rd Robert Britten | CAN |
| 4th Jeff Loosemore | AUS |
| 5th Tim Woodford | CAN |
| Women Grand Masters | |
| 1st Paule Samson | CAN |
| 2nd Judith Krimski | USA |
| Great Grand Masters | |
| 1st Robert Lowndes | AUS |
| 2nd Bill Symes | USA |
| 3rd Keith Wilkins | GBR |
| 4th Daniel Heigman | USA |
| 5th Michael Kinnear | GBR |
| Women Great Grand Masters | |
| 1st Hilary Thomas | GBR |
| Over 75 Masters | |
| 1st Peter Seidenberg | USA |
| 2nd Johan van Rossem | CAN |
| 3rd Michael Shields | NZL |
| 4th Heini Wellmann | SUI |
| 5th Geoffrey Lucas | AUS |
| Women Over 75 Masters | |
| 1st Deidre Webster | CAN |

| | |
|---------------------------------|-----|
| 2014 Hyeres, FRA | |
| Entries 499 Countries 36 | |
| Standard | |
| Apprentices | |
| 1st Adonis Bougiouris | GRE |
| 2nd Marciel Grabowski | POL |
| 3rd Matt Blakey | NZL |
| 4th Angelo Taberner | ESP |
| 5th Urban Nyhammar | SWE |

| | |
|------------------------------|-----|
| Masters | |
| 1st Brett Beyer | AUS |
| 2nd Arnold Hummel | NED |
| 3rd Peter Shope | USA |
| 4th Scott Ferguson | USA |
| 5th Christian Gunni Pedersen | DEN |
| Grand Masters | |
| 1st Nick Harrison | GBR |
| 2nd Andy Roy | CAN |
| 3rd Peter Vessella | USA |
| 4th Colin Dibb | AUS |
| 5th Wolfgang Gerz | GER |
| Great Grand Masters | |
| 1st Mark Bethwaite | AUS |
| 2nd Robert Blakey | NZL |
| 3rd John Dawson Edwards | CAN |
| 4th John Roberson | AUS |
| 5th Christopher Fyans | GBR |

| | |
|--------------------------|-----|
| Radial | |
| Apprentices | |
| 1st Jon Emmett | GBR |
| 2nd Scott Leith | NZL |
| 3rd Alp Alpagut | TUR |
| 4th Iago Matately | BRA |
| 5th Edurne Llanusa | NZL |
| Women Apprentices | |
| 1st Monica Azon | ESP |
| 2nd Cecile Venaut | FRA |
| 3rd Caroline Muselet | CAN |
| 4th Alexandra Wehrauch | GER |
| Masters | |
| 1st Stephen Cockerill | GBR |
| 2nd Mark Kennedy | AUS |
| 3rd Joao Ramos | BRA |
| 4th Richard Blakey | NZL |
| 5th Ian Jones | GBR |

| | |
|----------------------------|-----|
| Women Masters | |
| 1st Helene Viazzo | FRA |
| 2nd Agneta Jonsson | SWE |
| 3rd Diane Sissingh | AUS |
| 4th Claudine Tatibout | FRA |
| 5th Giovanna Locu | ITA |
| Grand Masters | |
| 1st Michael Keeton | NZL |
| 2nd Jeff Loosemore | AUS |
| 3rd Terry Scutcher | GBR |
| 4th Vanessa Dudley | AUS |
| 5th Brett Wright | BER |
| Women Grand Masters | |
| 1st Vanessa Dudley | AUS |
| 2nd Ann Keates | GBR |
| 3rd Lyndall Patterson | AUS |
| 4th Isabelle Arnaud | FRA |
| 5th Lesley Reichenfeld | CAN |

| | |
|----------------------------------|-----|
| Great Grand Masters | |
| 1st Keith Wilkins | GBR |
| 2nd Robert Lowndes | AUS |
| 3rd Peter Seidenberg | USA |
| 4th Jacky Nebrel | FRA |
| 5th Bill Symes | USA |
| Women Great Grand Masters | |
| 1st Hilary Thomas | GBR |
| Over 75 Masters | |
| 1st Peter Seidenberg | USA |
| 2nd Kerry Waraker | USA |
| 3rd Benita O'Sullivan | IRL |
| 4th Ken Holiday | USA |
| 5th Peter Craig | AUS |
| Women Over 75 Masters | |
| 1st Deidre Webster | CAN |

| | |
|----------------------------|-----|
| 4.7 | |
| Masters | |
| 1st Stephen Walsh | AUS |
| 2nd Akemi Nagaoka | JPN |
| 3rd Waltraud Schmitt | FRA |
| 4th Jean-Francois Farrugia | FRA |
| Women Masters | |
| 1st Akemi Nagaoka | JPN |
| 2nd Waltraud Schmitt | FRA |

| | |
|---------------------------------|-----|
| 2013 Al Mussanah, OMA | |
| Entries 186 Countries 31 | |
| Standard | |
| Apprentices | |
| 1st Scott Leith | NZL |
| 2nd Niklas Edler | SWE |
| 3rd Alastair Tate | NZL |
| 4th Kris Decke | NZL |
| 5th Alan Coutts | OMA |
| Masters | |
| 1st Al Clark | CAN |
| 2nd Arnold Hummel | NED |
| 3rd Chris Dawson | AUS |
| 4th Bernd Meesemaeker | FRA |
| 5th Torbjorn Jonsson | SWE |
| Grand Masters | |
| 1st Greg Adams | AUS |
| 2nd Terry Scutcher | GBR |
| 3rd Wolfgang Gerz | GER |
| 4th Tim Law | GBR |
| 5th Robert Britten | CAN |

| | |
|----------------------------|-----|
| Great Grand Masters | |
| 1st Mark Bethwaite | AUS |
| 2nd Robert Blakey | NZL |
| 3rd John Roberson | AUS |
| 4th Sandy Grigg | NZL |
| 5th Stephen Wawn | AUS |
| Radial | |
| Apprentices | |
| 1st Jon Emmett | GBR |
| 2nd Fabio Syama Ramos | BRA |
| 3rd Edmund Tam | NZL |
| 4th Ian Gregory | GBR |
| 5th Niall Peelo | GBR |
| Women Apprentices | |
| 1st Kimberly Couranz | USA |
| 2nd Alexandra Wehrauch | GER |
| Masters | |
| 1st Ian Jones | GBR |
| 2nd Joao Ramos | BRA |
| 3rd Martin Van Offlen | NED |
| 4th Matthias Bruhl | GER |
| 5th Robert Cage | GBR |
| Women Masters | |
| 1st Agneta Jonsson | SWE |
| 2nd Diane Sissingh | AUS |
| 3rd Martien Zeegers-Nouwen | NED |
| 4th Lindsay Whitton | AUS |
| Grand Masters | |
| 1st Vanessa Dudley | AUS |
| 2nd Bruce Martinson | USA |
| 3rd Michael Pridham | GBR |
| 4th Doug Peckover | USA |
| 5th Bo Johannisson | SWE |
| Women Grand Masters | |
| 1st Vanessa Dudley | AUS |

| | |
|----------------------------------|-----|
| Great Grand Masters | |
| 1st Peter Seidenberg | USA |
| 2nd Keith Wilkins | GBR |
| 3rd Henk Wittenberg | NED |
| 4th Michael Kinnear | GBR |
| 5th Steve Avery | USA |
| Women Great Grand Masters | |
| 1st Hilary Thomas | GBR |
| 2nd Elaine Capps | AUS |

| | |
|---------------------------------|-----|
| 2012 Brisbane, AUS | |
| Entries 232 Countries 19 | |
| Standard | |
| Apprentices | |
| 1st Matias Del Solar | CHI |
| 2nd Tony Baisten | AUS |
| 3rd Brett Morris | AUS |
| 4th Kent Coppelstone | NZL |
| 5th Rob Woodward | NZL |
| Masters | |
| 1st Brett Beyer | AUS |
| 2nd Bradley Taylor | AUS |
| 3rd Sean Atherton-Feeney | AUS |
| 4th Andrew Dellabarca | NZL |
| 5th Mike Matan | GBR |
| Grand Masters | |
| 1st Wolfgang Gerz | GER |
| 2nd Tracy Usher | USA |
| 3rd Andre Martinie | DOM |
| 4th Malcolm Courts | GBR |
| 5th Mark Bethwaite Am | AUS |

| | |
|----------------------------|-----|
| Radial | |
| Apprentices | |
| 1st Scott Leith | NZL |
| 2nd Edmund Tam | NZL |
| 3rd Ian Gregory | GBR |
| 4th Joe Burcar | USA |
| 5th Pablo Cervantes | MEX |
| Women Apprentices | |
| 1st Buff Wendt | USA |
| 2nd Michelle Davis | USA |
| 3rd Kate Easton | CAN |
| Masters | |
| 1st Al Clark | CAN |
| 2nd Carlos E. Wanderley | BRA |
| 3rd Marcelo Fuchs | BRA |
| 4th Gary Ratcliffe | AUS |
| 5th Mark Page | NZL |
| Women Masters | |
| 1st Diane Sissingh | AUS |
| 2nd Isabelle Barbeau | TAH |
| Grand Masters | |
| 1st William Symes | USA |
| 2nd Bruce Martinson | USA |
| 3rd Robert Lowndes | AUS |
| 4th Peter Heywood | AUS |
| 5th Walt Spvak | USA |
| Women Grand Masters | |
| 1st Lesley Reichenfeld | CAN |
| 2nd Irina Pashutin | ISR |
| 3rd Kathy Luciano | USA |
| Great Grand Masters | |
| 1st Keith Wilkins | GBR |
| 2nd Peter Seidenberg | USA |
| 3rd Jim Quinn | NZL |
| 4th Lindsay Hewitt | USA |
| 5th Michael Kinnear | GBR |

| | |
|---------------------------------|-----|
| 2010 Haying Island, GBR | |
| Entries 354 Countries 31 | |
| Standard | |
| Apprentices | |
| 1st Brett Beyer | AUS |
| 2nd Adonis Bougiouris | GRE |
| 3rd Jyrki Taiminen | FIN |
| 4th Orlando Gledhill | GBR |
| 5th Benjamin Richardson | USA |
| Masters | |
| 1st Scott Ferguson | USA |
| 2nd Arnold Hummel | NED |
| 3rd John Bertrand | USA |
| 4th Christian Gunni Pedersen | DEN |
| 5th Al Clark | CAN |

| | |
|----------------------------------|-----|
| Women Grand Masters | |
| 1st Lyndall Patterson | AUS |
| 2nd Lesley Reichenfeld | CAN |
| Great Grand Masters | |
| 1st Kerry Waraker | AUS |
| 2nd Keith Wilkins | GBR |
| 3rd Peter Seidenberg | USA |
| 4th Kevin Phillips | AUS |
| 5th Lew Verdon | AUS |
| Women Great Grand Masters | |
| 1st Hilary Thomas | GBR |

| | |
|----------------------|-----|
| 4.7 | |
| Masters | |
| 1st Claire Heenan | AUS |
| 2nd Peter Charlton | AUS |
| 3rd George Meikle | AUS |
| 4th Martin Brady | AUS |
| 5th Bronwyn Mitchell | AUS |
| Women Masters | |
| 1st Claire Heenan | AUS |
| 2nd Bronwyn Mitchell | AUS |
| 3rd Michelle Lefevre | RSA |
| 4th Janet Kemp | AUS |
| 5th Jenny Walker | AUS |

| | |
|---------------------------------|-----|
| 2011 San Francisco, USA | |
| Entries 236 Countries 27 | |
| Standard | |
| Apprentices | |
| 1st Benjamin Richardson | USA |
| 2nd Orlando Gledhill | GBR |
| 3rd Kevin Taugher | USA |
| 4th Gaspare Silvestri | ITA |
| 5th David Armitage | USA |
| Masters | |
| 1st Arnold Hummel | NED |
| 2nd Brett Beyer | AUS |
| 3rd Scott Ferguson | USA |
| 4th Keith Wilkins | GBR |
| 5th Otto Strandvig | DEN |
| Grand Masters | |
| 1st Colin Dibb | AUS |
| 2nd Peter Vessella | USA |
| 3rd Malcolm Courts | GBR |
| 4th Lard Hansen | USA |
| 5th Wolfgang Gerz | GER |

| | |
|----------------------------|-----|
| Radial | |
| Apprentices | |
| 1st Scott Leith | NZL |
| 2nd Edmund Tam | NZL |
| 3rd Ian Gregory | GBR |
| 4th Joe Burcar | USA |
| 5th Pablo Cervantes | MEX |
| Women Apprentices | |
| 1st Buff Wendt | USA |
| 2nd Michelle Davis | USA |
| 3rd Kate Easton | CAN |
| Masters | |
| 1st Al Clark | CAN |
| 2nd Carlos E. Wanderley | BRA |
| 3rd Marcelo Fuchs | BRA |
| 4th Gary Ratcliffe | AUS |
| 5th Mark Page | NZL |
| Women Masters | |
| 1st Diane Sissingh | AUS |
| 2nd Isabelle Barbeau | TAH |
| Grand Masters | |
| 1st William Symes | USA |
| 2nd Bruce Martinson | USA |
| 3rd Robert Lowndes | AUS |
| 4th Peter Heywood | AUS |
| 5th Walt Spvak | USA |
| Women Grand Masters | |
| 1st Lesley Reichenfeld | CAN |
| 2nd Irina Pashutin | ISR |
| 3rd Kathy Luciano | USA |
| Great Grand Masters | |
| 1st Keith Wilkins | GBR |
| 2nd Peter Seidenberg | USA |
| 3rd Jim Quinn | NZL |
| 4th Lindsay Hewitt | USA |
| 5th Michael Kinnear | GBR |

| | |
|---------------------------------|-----|
| 2010 Haying Island, GBR | |
| Entries 354 Countries 31 | |
| Standard | |
| Apprentices | |
| 1st Brett Beyer | AUS |
| 2nd Adonis Bougiouris | GRE |
| 3rd Jyrki Taiminen | FIN |
| 4th Orlando Gledhill | GBR |
| 5th Benjamin Richardson | USA |
| Masters | |
| 1st Scott Ferguson | USA |
| 2nd Arnold Hummel | NED |
| 3rd John Bertrand | USA |
| 4th Christian Gunni Pedersen | DEN |
| 5th Al Clark | CAN |

| | |
|----------------------|-----|
| Grand Masters | |
| 1st Wolfgang Gerz | GER |
| 2nd Peter Vessella | USA |
| 3rd Peter Sherwin | GBR |
| 4th Peter Sundelin | SWE |
| 5th William Symes | USA |

| | |
|----------------------------|-----|
| Radial | |
| Apprentices | |
| 1st Scott Leith | NZL |
| 2nd Jean-Christophe Leydet | FRA |
| 3rd Matthias Bruehl | GER |
| 4th Ian Jones | GBR |
| 5th Edmund Tam | NZL |

| | |
|--------------------------|-----|
| Women Apprentices | |
| 1st Caroline Muelet | CAN |
| 2nd Rosie Tribe | GBR |
| 3rd Brenda Hoult | GBR |

| | |
|-------------------------|-----|
| Masters | |
| 1st Stephen Cockerill | GBR |
| 2nd Joao Ramos | BRA |
| 3rd Hamish Atkinson | NZL |
| 4th Carlos E. Wanderley | BRA |
| 5th Ian Escritt | GBR |

| | |
|----------------------|-----|
| Women Masters | |
| 1st Christine Bridge | AUS |
| 2nd Agnetta Jonsson | SWE |
| 3rd Vanessa Dudley | AUS |

| | |
|-----------------------|-----|
| Grand Masters | |
| 1st Lyndall Patterson | AUS |
| 2nd Alden Shattuck | USA |
| 3rd Bruce Martinson | USA |
| 4th Mark Halman | USA |
| 5th Kevin Pearson | GBR |

| | |
|----------------------------|-----|
| Women Grand Masters | |
| 1st Lyndall Patterson | AUS |
| 2nd Janet Kemp | AUS |

| | |
|----------------------------|-----|
| Great Grand Masters | |
| 1st Keith Wilkins | GBR |
| 2nd Peter Seidenberg | USA |
| 3rd Johan Stam | NED |
| 4th Jim Quinn | NZL |
| 5th Kerry Waraker | AUS |

| | |
|----------------------------------|-----|
| Women Great Grand Masters | |
| 1st Hilary Thomas | GBR |
| 2nd Deirdre Webster | CAN |

2009 Halifax, CAN
Entries 295 Countries 26

| | |
|-----------------------|-----|
| Standard | |
| Apprentices | |
| 1st Adonis Bougiouris | GRE |
| 2nd Brett Beyer | AUS |
| 3rd Orlando Gledhill | GBR |
| 4th Ray Davies | CAN |
| 5th Stewart Casey | AUS |

| | |
|---------------------|-----|
| Masters | |
| 1st Scott Ferguson | USA |
| 2nd Arnold Hummel | NED |
| 3rd Arnold Pimental | USA |
| 4th Mark Bear | USA |
| 5th Jan Scholten | AUS |

| | |
|----------------------|-----|
| Grand Masters | |
| 1st Wolfgang Gerz | GER |
| 2nd Mark Bethwaite | AUS |
| 3rd Alan Keen | RSA |
| 4th Jack Schlachter | AUS |
| 5th Bill Symes | USA |

| | |
|---------------------|-----|
| Radial | |
| Apprentices | |
| 1st Richard Bott | AUS |
| 2nd Scott Leith | NZL |
| 3rd Grant Willmott | AUS |
| 4th Edmund Tam | NZL |
| 5th Matthias Bruehl | GER |

| | |
|--------------------------|-----|
| Women Apprentices | |
| 1st Alison Casey | AUS |
| 2nd Yvonne Malmsten | SWE |
| 3rd Kimberley Couranz | USA |

| | |
|-------------------------|-----|
| Masters | |
| 1st Carlos E. Wanderley | BRA |
| 2nd Greg Adams | AUS |
| 3rd Joao Ramos | BRA |
| 4th Michael Knowsley | NZL |
| 5th Nigel Heath | CAN |

| | |
|-----------------------|-----|
| Women Masters | |
| 1st Lyndall Patterson | AUS |
| 2nd Vanessa Dudley | AUS |
| 3rd Agnetta Jonsson | SWE |

| | |
|----------------------|-----|
| Grand Masters | |
| 1st Peter Heywood | AUS |
| 2nd Michael Pridham | GBR |
| 3rd Ian Rawet | GBR |
| 4th Alden Shattuck | USA |
| 5th Kevin Pearson | GBR |

| | |
|----------------------------|-----|
| Women Grand Masters | |
| 1st Sally Sharp | USA |
| 2nd Hilary Thomas | GBR |
| 3rd Gill Waiting | NZL |

| | |
|----------------------------|-----|
| Great Grand Masters | |
| 1st Peter Seidenberg | USA |
| 2nd Kerry Waraker | AUS |
| 3rd Michael Kinnear | GBR |
| 4th Jim Quinn | NZL |
| 5th Lindsay Hewitt | USA |

Women Great Grand Masters
1st Deirdre Webster CAN

2008 Terrigal, AUS
Entries 370 Countries 22

| | |
|------------------------|-----|
| Standard | |
| Apprentices | |
| 1st Brett Beyer | AUS |
| 2nd Rohan Lord | NZL |
| 3rd Jyrki Taiminen | FIN |
| 4th Orlando Gledhill | GBR |
| 5th Christopher Gowers | GBR |

| | |
|--------------------|-----|
| Masters | |
| 1st Jan Scholten | AUS |
| 2nd Bradley Taylor | AUS |
| 3rd Peter Conde | AUS |
| 4th Andy Roy | CAN |
| 5th Colm Dibb | USA |

| | |
|----------------------|-----|
| Women Masters | |
| 1st Mark Bethwaite | AUS |
| 2nd Wolfgang Gerz | GER |
| 3rd Jack Schlachter | AUS |
| 4th Robert Lowndes | AUS |
| 5th Michael Nissen | GER |

Radial

| | |
|--------------------|-----|
| Apprentices | |
| 1st James Liebl | USA |
| 2nd John Jagger | AUS |
| 3rd Richard Bott | AUS |
| 4th Scott Leith | NZL |
| 5th David Early | AUS |

| | |
|--------------------------|-----|
| Women Apprentices | |
| 1st Alison Casey | AUS |
| 2nd Justine Ella | AUS |
| 3rd Yvonne Malmsten | SWE |

| | |
|-----------------------|-----|
| Masters | |
| 1st Mark Orams | NZL |
| 2nd Stephen Cockerill | GBR |
| 3rd Greg Adams | AUS |
| 4th Al Clark | CAN |
| 5th Chris Raab | USA |

| | |
|-----------------------|-----|
| Women Masters | |
| 1st Christine Bridge | AUS |
| 2nd Lyndall Patterson | AUS |
| 3rd Vanessa Dudley | AUS |

| | |
|----------------------|-----|
| Grand Masters | |
| 1st Peter Heywood | AUS |
| 2nd Brian Watson | AUS |
| 3rd Peter Whipp | GBR |
| 4th Lew Verdon | AUS |
| 5th Ian Rawet | GBR |

| | |
|----------------------------|-----|
| Women Grand Masters | |
| 1st Gill Waiting | NZL |

| | |
|----------------------------|-----|
| Great Grand Masters | |
| 1st Peter Seidenberg | USA |
| 2nd Kerry Waraker | AUS |
| 3rd Tom Speed | NZL |
| 4th Jim Quinn | NZL |
| 5th Howard Taylor | AUS |

2007 Roses, ESP
Entries 419 Countries 33

| | |
|-----------------------|-----|
| Standard | |
| Apprentices | |
| 1st Brett Beyer | AUS |
| 2nd Orlando Gledhill | GBR |
| 3rd Stephen Cockerill | GBR |
| 4th Xav Leclair | FRA |
| 5th Erasun Echavarrri | ESP |

| | |
|--------------------|-----|
| Masters | |
| 1st Arnold Hummel | NED |
| 2nd Al Clark | CAN |
| 3rd Cesar Sierhuis | NED |
| 4th Scott Ferguson | USA |
| 5th Peter Vessella | USA |

| | |
|----------------------|-----|
| Grand Masters | |
| 1st Mark Bethwaite | AUS |
| 2nd Michael Nissen | GER |
| 3rd Anders Sorensson | SWE |
| 4th Jack Schlachter | AUS |
| 5th William Symes | USA |

| | |
|------------------------|-----|
| Radial | |
| Apprentices | |
| 1st Mark | NZL |
| 2nd Freak Miranda | NED |
| 3rd Wilmar Groenendijk | NED |
| 4th Matthias Bruehl | GER |
| 5th David Early | AUS |

| | |
|--------------------------|-----|
| Women Apprentices | |
| 1st Agnetta Jonsson | SWE |
| 2nd Yvonne Malmsten | SWE |
| 3rd Christelle Marsault | FRA |

| | |
|---------------------------|-----|
| Masters | |
| 1st Greg Adams | AUS |
| 2nd Robert Cage | GBR |
| 3rd Martin Baltischeffsky | FIN |
| 4th John Reay | GBR |
| 5th Richard Major | GBR |

| | |
|------------------------|-----|
| Women Masters | |
| 1st Lyndall Patterson | AUS |
| 2nd Janet Kemp | AUS |
| 3rd Claudine Fatibouet | FRA |

| | |
|----------------------|-----|
| Grand Masters | |
| 1st Peter Heywood | AUS |
| 2nd Peter Whipp | GBR |
| 3rd Alden Shattuck | USA |
| 4th Ian Rawet | GBR |
| 5th Serge Raphalen | FRA |

| | |
|----------------------------|-----|
| Women Grand Masters | |
| 1st Hilary Thomas | GBR |
| 2nd Caroline Marriage | GBR |

| | |
|----------------------------|-----|
| Great Grand Masters | |
| 1st Peter Seidenberg | USA |
| 2nd Kerry Waraker | AUS |
| 3rd Heini Wellmann | SUI |
| 4th Greg Marshall | AUS |
| 5th Bill Watson | GBR |

Women Great Grand Masters
1st Deirdre Webster CAN

2006 Jeju Island, KOR
Entries 72 Countries 14

| | |
|----------------------|-----|
| Standard | |
| Apprentices | |
| 1st Brett Beyer | AUS |
| 2nd Orlando Gledhill | GBR |
| 3rd Giles Grigg | NZL |
| 4th Richard Blakey | NZL |
| 5th Kevin Currier | IRL |

| | |
|--------------------|-----|
| Masters | |
| 1st Brodie Cobb | USA |
| 2nd Tracy Usher | USA |
| 3rd Mark Bear | USA |
| 4th Andrew Martini | DOM |
| 5th Malcolm Courts | GBR |

| | |
|------------------------|-----|
| Grand Masters | |
| 1st Doug Peckover | USA |
| 2nd Robert Lowndes | AUS |
| 3rd Derek Breitenstein | FIN |
| 4th Bob Blakey | NZL |
| 5th Ken Brown | CAN |

Radial

| | |
|----------------------|-----|
| Apprentices | |
| 1st Steve Cockerill | GBR |
| 2nd Mark Page | NZL |
| 3rd David Early | AUS |
| 4th Christine Bridge | AUS |

| | |
|---------------------------|-----|
| Masters | |
| 1st Greg Adams | AUS |
| 2nd Bruce Martinson | AUS |
| 3rd Martin Baltischeffsky | FIN |
| 4th Lyndall Patterson | AUS |
| 5th Gregory Kemp | AUS |

| | |
|----------------------|-----|
| Grand Masters | |
| 1st Alden Shattuck | AUS |
| 2nd Peter Whipp | GBR |
| 3rd Ian Rawet | GBR |
| 4th Mark Miller | NZL |
| 5th Hann Thomas | GBR |

| | |
|----------------------------|-----|
| Great Grand Masters | |
| 1st Peter Seidenberg | USA |
| 2nd Kerry Waraker | AUS |
| 3rd Sandy Grigg | NZL |
| 4th Tom Speed | NZL |
| 5th Gregg Marshall | AUS |

| | |
|-----------------------|-----|
| Women | |
| 1st Christine Bridge | AUS |
| 2nd Lyndall Patterson | AUS |
| 3rd Janet Kemp | AUS |
| 4th Hilary Thomas | GBR |
| 5th Lesley Hotchin | GBR |

2005 Fortaleza, BRA
Entries 183 Countries 25

| | |
|--------------------|-----|
| Standard | |
| Apprentices | |
| 1st Brett Beyer | AUS |
| 2nd Xavier Leclair | FRA |
| 3rd Scott Ferguson | USA |
| 4th Mark Page | NZL |
| 5th Larry Kleist | AUS |

| | |
|---------------------|-----|
| Masters | |
| 1st Murray Thom | NZL |
| 2nd Peter Conde | AUS |
| 3rd Kurt Miller | USA |
| 4th Gonzalo Campero | ARG |
| 5th Vann Wilson | USA |

| | |
|-------------------------|-----|
| Grand Masters | |
| 1st Mark Bethwaite | AUS |
| 2nd Nicolas Livingstone | GBR |
| 3rd Keith Wilkins | GBR |
| 4th Ted Moore | USA |
| 5th John Dawson Edwards | CAN |

| | | |
|------------------------|-----------|-----|
| Radial | | |
| Apprentices | | |
| 1st Mark Orams | NZL | |
| 2nd Stephen Cockerill | GBR | |
| 3rd Carlos Eduardo - | Wanderley | BRA |
| 4th David Early | HKG | |
| 5th Wilmar Groenendijk | NED | |

| | |
|--------------------------|-----|
| Women Apprentices | |
| 1st Kim Ferguson | USA |
| 2nd Lisa Garaty | AUS |

| | |
|--------------------------|-----|
| Masters | |
| 1st Alexander Nikolaev | RUS |
| 2nd Adam French | AUS |
| 3rd Chris Raab | USA |
| 4th Aldo Cezar Guimaraes | BRA |
| 5th Lyndall Patterson | AUS |

| | |
|-----------------------|-----|
| Women Masters | |
| 1st Lyndall Patterson | AUS |
| 2nd Janet Kemp | AUS |
| 3rd Kathy Herrmann | AUS |

| | |
|----------------------|-----|
| Grand Masters | |
| 1st Peter Heywood | AUS |
| 2nd Gary McCrohon | AUS |
| 3rd Alden Shattuck | USA |
| 4th Poopy Marcon | FRA |
| 5th Peter Whipp | GBR |

| | |
|----------------------------|-----|
| Great Grand Masters | |
| 1st Kerry Waraker | AUS |
| 2nd Peter Seidenberg | USA |
| 3rd Denis O'Sullivan | IRL |
| 4th Heini Wellmann | SUI |
| 5th Sandy Grigg | NZL |

2004 Bitez, TUR
Entries 153 Countries 30

| | |
|-----------------------|-----|
| Standard | |
| Apprentices | |
| 1st Brett Beyer | AUS |
| 2nd Stephen Cockerill | GBR |
| 3rd Martin Leishner | AUT |
| 4th Nick Walsh | IRL |
| 5th Mati Sepp | EST |

| | |
|---------------------|-----|
| Masters | |
| 1st Colin Dibb | AUS |
| 2nd Jack Schlachter | AUS |
| 3rd Tracy Usher | USA |
| 4th Brett Wright | BER |
| 5th Mark Bear | USA |

| | |
|----------------------|-----|
| Grand Masters | |
| 1st Mark Bethwaite | AUS |
| 2nd Magnus Olin | SWE |
| 3rd David Edmiston | AUS |
| 4th Robert Lowndes | AUS |
| 5th Sandy Grigg | NZL |

| | |
|---------------------------|-----|
| Radial | |
| Apprentices | |
| 1st David Early | HKG |
| 2nd Aydin Yurdum | TUR |
| 3rd Martin Baltischeffsky | FIN |
| 4th Bulent Baha Akin | TUR |
| 5th Claudio Gallizioli | ITA |

| | |
|--------------------------|-----|
| Women Apprentices | |
| 1st Yvonne Malmsten | SWE |

| | |
|-----------------------|-----|
| Masters | |
| 1st Goran Bonacic | CRO |
| 2nd Lyndall Patterson | AUS |
| 3rd Bruce Martinson | USA |
| 4th Olivier Falque | FRA |
| 5th Laurent vigo | FRA |

| | |
|-----------------------|-----|
| Women Masters | |
| 1st Lyndall Patterson | AUS |

| | |
|----------------------|-----|
| Grand Masters | |
| 1st Poopy Marcon | FRA |
| 2nd Alden Shattuck | USA |
| 3rd Peter Whipp | GBR |
| 4th Heini Wellmann | SUI |
| 5th Mark Miller | NZL |

| | |
|----------------------------|-----|
| Great Grand Masters | |
| 1st Peter Seidenberg | USA |
| 2nd Jack Hansen | NZL |
| 3rd Kenneth Holliday | RSA |
| 4th Denis O'Sullivan | IRL |
| 5th David Flakelar | AUS |

2003 Cadiz, ESP
Entries 236 Countries 27

| | |
|-----------------------|-----|
| Standard | |
| Apprentices | |
| 1st Mark Littlejohn | GBR |
| 2nd Stephen Cockerill | GBR |
| 3rd Brett Beyer | AUS |
| 4th Jyrki Taiminen | FIN |
| 5th Huub Lambriex | NED |

| | |
|------------------------|-----|
| Masters | |
| 1st Anders Sorensson | SWE |
| 2nd Chris Raab | USA |
| 3rd Malcolm Courts | GBR |
| 4th Nick Harrison | GBR |
| 5th Alexander Nikolaev | RUS |

| | |
|----------------------|-----|
| Grand Masters | |
| 1st Mark Bethwaite | AUS |
| 2nd Keith Wilkins | GBR |
| 3rd Kevin Pearson | GBR |
| 4th Kim Weber | FIN |
| 5th William Symes | USA |

| | |
|---------------------------|-----|
| Radial | |
| Apprentices | |
| 1st Wilmar Groenendijk | NED |
| 2nd Thomas Deimling | GER |
| 3rd Roberta Hartley | GBR |
| 4th Martin Baltischeffsky | FIN |
| 5th Luis Martin Propato | ARG |

| | |
|--------------------------|-----|
| Women Apprentices | |
| 1st Roberta Hartley | GBR |
| 2nd Yvonne Malmsten | SWE |
| 3rd Susan Brown | GBR |

| | |
|------------------------|-----|
| Masters | |
| 1st Alastair McMichael | AUS |
| 2nd Bruce Martinson | USA |
| 3rd Lyndall Patterson | AUS |
| 4th Christian Borenus | FIN |
| 5th Peter Whipp | GBR |

| | |
|-----------------------|-----|
| Women Masters | |
| 1st Lyndall Patterson | AUS |
| 2nd Jan Kemp | AUS |
| 3rd Okumura Hiroko | JPN |

| | |
|----------------------|-----|
| Grand Masters | |
| 1st Alden Shattuck | USA |
| 2nd Henk Wittenberg | NED |
| 3rd Gary McCrohon | AUS |
| 4th Roger Williams | BER |
| 5th Gerard Jeannot | FRA |

| | |
|----------------------------|-----|
| Great Grand Masters | |
| 1st Peter Seidenberg | USA |
| 2nd Tom Speed | NZL |
| 3rd Bill Watson | GBR |
| 4th Heinz Gebauer | CAN |
| 5th Denis O'Sullivan | IRL |

2002 Hyannis, USA
Entries 270 Countries 24

Standard

| | |
|---------------------|-----|
| Apprentices | |
| 1st Andreas John | GER |
| 2nd Brett Beyer | AUS |
| 3rd Mark Littlejohn | GBR |
| 4th Andrew Pimental | USA |
| 5th Jyrki Taiminen | FIN |

| | |
|--------------------|-----|
| Masters | |
| 1st Ed Adams | USA |
| 2nd Mark Bear | USA |
| 3rd Peter Vessella | USA |
| 4th Charles Tripp | USA |
| 5th Tracy Usher | USA |

| | |
|----------------------|-----|
| Radial Open | |
| 1st Keith Wilkins | GBR |
| 2nd Bill Symes | USA |
| 3rd Peter Seidenberg | USA |
| 4th Robert Lowndes | AUS |
| 5th Jack Hansen | NZL |

Radial

| | |
|------------------------|-----|
| Apprentices | |
| 1st Stephen Cockerill | GBR |
| 2nd Mark Orams | NZL |
| 3rd Wilmar Groenendijk | NED |
| 4th Ryan Minth | USA |
| 5th Robert Falk | USA |

| | |
|---------------------|-----|
| Masters | |
| 1st Adam French | AUS |
| 2nd Alden Shattuck | USA |
| 3rd Bruce Martinson | USA |
| 4th Diane Burton | USA |
| 5th Richard Ineson | NZL |

| | |
|----------------------|-----|
| Great Masters | |
| 1st Lindsay Hewitt | USA |
| 2nd Colin Maddren | NZL |
| 3rd Mark Miller | NZL |
| 4th James Johnston | USA |
| 5th Lew Vernon | AUS |

| | |
|----------------------------|-----|
| Great Grand Masters | |
| 1st Dick Tillman | USA |
| 2nd Henry de Wolf Jr. | USA |
| 3rd Heinz Gebauer | CAN |
| 4th Jim Christopher | GBR |
| 5th Peter Raymer | GBR |

| | |
|---------------------|-----|
| Women | |
| 1st Diane Burton | USA |
| 2nd Jane Codman | USA |
| 3rd Sally Sharp | AUS |
| 4th Yvonne Malmsten | SWE |
| 5th Debbie Phillips | GBR |

2001 Cork, IRL
Entries 314 Countries 25

Standard

| | |
|---------------------|-----|
| Apprentices | |
| 1st Brett Beyer | AUS |
| 2nd Mark Littlejohn | GBR |
| 3rd Doug McGain | AUS |
| 4th Mark Lyttle | IRL |
| 5th Marc Jacobi | USA |

| | |
|---------------------|-----|
| Masters | |
| 1st Colin Dibb | AUS |
| 2nd Jan Lineberger | CAN |
| 3rd Anders Sorenson | SWE |
| 4th Mark Bethwaite | AUS |
| 5th Malcolm Courts | GBR |

| | |
|----------------------|-----|
| Great Masters | |
| 1st Keith Wilkins | GBR |
| 2nd Philip Pegler | AUS |
| 3rd Jacky Nebrel | FRA |
| 4th Bob Blakey | NZL |
| 5th Barry Waller | AUS |

Radial

| | |
|----------------------------|-----|
| Great Grand Masters | |
| 1st Henry de Wolf Jr. | USA |
| 2nd Fradin Schoettle | USA |
| 3rd Heinz Gebauer | CAN |
| 4th Anthony Denham | AUS |
| 5th James Christopher | USA |

| | |
|------------------------|-----|
| Radial Open | |
| 1st Stephen Cockerill | GBR |
| 2nd Wilmar Groenendijk | NED |
| 3rd Thomas Urban | SWE |
| 4th John Reay | GBR |
| 5th Jean Luc Michon | FRA |

| | |
|-----------------------|-----|
| Radial Women | |
| 1st Roberta Hartley | GBR |
| 2nd Lyndall Patterson | AUS |
| 3rd Claire Davison | GBR |
| 4th Yvonne Malmsten | SWE |
| 5th Jan Kemp | AUS |

2000 Cancun, MEX
Entries 147 Countries 20

Standard

| | |
|------------------------|-----|
| Apprentices | |
| 1st Alan Davis | GBR |
| 2nd Alexandre Nikolaev | RUS |
| 3rd Terry Scutcher | GBR |
| 4th Bill O'Hara | IRL |
| 5th Martin Hallsten | SWE |

| | |
|---------------------|-----|
| Masters | |
| 1st Mark Bethwaite | AUS |
| 2nd Rob Coultis | NZL |
| 3rd Doug Peckover | USA |
| 4th Jack Schlachter | AUS |
| 5th Alan Keen | RSA |

| | |
|----------------------|-----|
| Great Masters | |
| 1st Keith Wilkins | GBR |
| 2nd Dick Tillman | USA |
| 3rd Joe van Rossem | CAN |
| 4th Ian Rawet | GBR |
| 5th Tom Speed | NZL |

Radial

| | |
|----------------------------|-----|
| Great Grand Masters | |
| 1st Henry de Wolf Jr. | USA |
| 2nd Kurt Zueger | SUI |
| 3rd Heinz Gebauer | CAN |
| 4th Geoffrey Myburgh | RSA |
| 5th Robert Saltmarsh | USA |

| | |
|------------------------|-----|
| Radial Open | |
| 1st Adam French | AUS |
| 2nd Wilmar Groenendijk | NED |
| 3rd Glyn Purnell | GBR |
| 4th Lew Verdon | AUS |
| 5th Henry de Wolf Jr. | USA |

| | |
|---------------------|-----|
| Radial Women | |
| 1st Sally Sharp | USA |
| 2nd Jennie King | GBR |
| 3rd Karyn Voos | USA |
| 4th Alison Knight | IVB |

1999 Melbourne, AUS
Entries 237 Countries 22

Standard

| | |
|---------------------|-----|
| Apprentices | |
| 1st Mark Littlejohn | GBR |
| 2nd Andrew John | GER |
| 3rd Alan Davis | GBR |
| 4th Bill O'Hara | IRL |
| 5th Brad Taylor | AUS |

| | |
|-----------------------|-----|
| Masters | |
| 1st Keith Wilkins | GBR |
| 2nd Peter Sundeim | SWE |
| 3rd Doug Peckover | USA |
| 4th Jack Schlachter | AUS |
| 5th Timothy Alexander | AUS |

| | |
|----------------------|-----|
| Grand Masters | |
| 1st Graham Oborn | AUS |
| 2nd Jack Hansen | NZL |
| 3rd Keith Vann | NZL |
| 4th Ben Piefke | AUS |
| 5th Kerry Waraker | AUS |

Radial

| | |
|----------------------------|-----|
| Great Grand Masters | |
| 1st Graham Read | AUS |
| 2nd Haruyoshi Kimura | JPN |
| 3rd Geoffrey Myburgh | RSA |
| 4th Kurt Zueger | SUI |
| 5th Peter O'Grady | AUS |

| | |
|------------------------|-----|
| Radial Open | |
| 1st Mark Orams | NZL |
| 2nd Alexandre Nikolaev | RUS |
| 3rd Frank Innon | AUS |
| 4th Wilmar Groenendijk | NED |
| 5th Adam French | AUS |

| | |
|-----------------------|-----|
| Radial Women | |
| 1st Lyndall Patterson | AUS |
| 2nd Helen Cooksey | AUS |
| 3rd Sally Sharp | USA |
| 4th Susan Fielding | AUS |
| 5th Lesley Hotchin | GBR |

1997 Algarrobo, CHI
Entries 128 Countries 21

Standard

| | |
|---------------------|-----|
| Apprentices | |
| 1st Herman Cristian | CHI |
| 2nd Alan Davis | GBR |
| 3rd Marcelo Fuschs | BRA |
| 4th Terry Scutcher | GBR |
| 5th Bill O'Hara | IRL |

| | |
|---------------------|-----|
| Masters | |
| 1st Doug Peckover | USA |
| 2nd Mark Bethwaite | AUS |
| 3rd Keith Wilkins | GBR |
| 4th Jack Schlachter | AUS |
| 5th Barry Waller | AUS |

| | |
|-----------------------|-----|
| Great Masters | |
| 1st Colin Lovelady | AUS |
| 2nd Peter Seidenberg | USA |
| 3rd Wilhelm Gerlinger | GER |
| 4th Joe Van Rossem | CAN |
| 5th Jack Hansen | NZL |

Radial

| | |
|----------------------------|-----|
| Great Grand Masters | |
| 1st Heinz Gebauer | CAN |
| 2nd Doug Bates | NZL |
| 3rd Graham Reed | AUS |
| 4th Peter Raymer | GBR |
| 5th Robert Saltmarsh | USA |

| | |
|------------------------|-----|
| Radial Open | |
| 1st Wilmar Groenendijk | NED |
| 2nd Aydin Yurdum | TUR |
| 3rd Alexandre Nikolaev | RUS |
| 4th Gary McCrohon | AUS |
| 5th Heinz Gebauer | CAN |

1996 Cape Town, RSA
Entries 155 Countries 21

Standard

| | |
|---------------------|-----|
| Apprentices | |
| 1st Peter Wilson | RSA |
| 2nd Robert Douglass | AUS |
| 3rd Regis Berenguer | FRA |
| 4th Terry Scutcher | GBR |
| 5th Chris Rodowicz | AUS |

| | |
|--------------------|-----|
| Masters | |
| 1st Keith Wilkins | GBR |
| 2nd Mark Bethwaite | AUS |
| 3rd Alan Keen | RSA |
| 4th Barry Waller | AUS |
| 5th Doug Peckover | USA |

| | |
|----------------------|-----|
| Great Masters | |
| 1st Ben Piefke | AUS |
| 2nd Denis O'Sullivan | IRL |
| 3rd Colin Lovelady | AUS |
| 4th Peter Seidenberg | USA |
| 5th Ken Holiday | RSA |

Radial

| | |
|------------------------|-----|
| Radial Open | |
| 1st Adam French | AUS |
| 2nd Alexandre Nikolaev | RUS |
| 3rd Kevin Bloor | AUS |
| 4th Rui Sancho | ANG |
| 5th Gary McCrohon | AUS |

1995 Tenerife, ESP
Entries 113 Countries 20

Apprentices

| | |
|-----------------------|-----|
| 1st Nicholas Harrison | GBR |
| 2nd Lance Burger | RSA |
| 3rd Tomas Franzen | SWE |
| 4th Peter Saxton | GBR |
| 5th Norio Akiyama | JPN |

| | |
|-------------------|-----|
| Masters | |
| 1st Keith Wilkins | GBR |
| 2nd Barry Waller | AUS |
| 3rd Ted Moore | USA |
| 4th Pieter Dekker | NED |
| 5th Jacky Nebrel | FRA |

Great Masters

| | |
|----------------------|-----|
| 1st Colin Lovelady | AUS |
| 2nd Peter Seidenberg | USA |
| 3rd Jack Hansen | NZL |
| 4th Joe Van Rossem | CAN |
| 5th Michael Heath | AUS |

1994 Wakayama, JPN
Entries 131 Countries 15

Apprentices

| | |
|-----------------------|-----|
| 1st Norio Akiyama | JPN |
| 2nd Nicholas Harrison | GBR |
| 3rd Nelson Horn Ilha | BRA |
| 4th Koichiro Naito | JPN |
| 5th Doug Peckover | USA |

Masters

| | |
|---------------------|-----|
| 1st Keith Wilkins | GBR |
| 2nd Hiroyuki Uehara | JPN |
| 3rd Mark Bethwaite | AUS |
| 4th Katsumi Hirano | JPN |
| 5th Ian Rawet | GBR |

Great Masters

| | |
|----------------------|-----|
| 1st Colin Lovelady | AUS |
| 2nd Peter Seidenberg | USA |
| 3rd Denis O'Sullivan | IRL |
| 4th Barry Pownall | AUS |
| 5th Tony Denham | AUS |

1993 Takapuna, NZL
Entries 186 Countries 22

Apprentices

| | |
|---------------------|-----|
| 1st Paul Page | NZL |
| 2nd Neville Littley | AUS |
| 3rd Murray Thom | NZL |
| 4th Andrew York | AUS |
| 5th Lance Burger | USA |

Masters

| | |
|--------------------|-----|
| 1st Keith Wilkins | GBR |
| 2nd John Rigg | AUS |
| 3rd Mark Bethwaite | AUS |
| 4th Barry Waller | AUS |
| 5th John Douglas | NZL |

Great Masters

| | |
|----------------------|-----|
| 1st Colin Lovelady | AUS |
| 2nd Denis O'Sullivan | USA |
| 3rd Barry Pownall | AUS |
| 4th Ralph Ellis | USA |
| 5th John Maynard | GBR |

Great Grand Masters

| | |
|----------------------|-----|
| 1st Doug Bates | NZL |
| 2nd Robert Saltmarsh | USA |

Women

| | |
|--------------------|-----|
| 1st Jill Robertson | CAN |
| 2nd Sally Sharp | USA |

1991 Porto Carras, GRE
Entries 107 Countries 23

Standard

| | |
|--------------------------|-----|
| Apprentices | |
| 1st Stephen Birbeck | GBR |
| 2nd Mark Phillips | AUS |
| 3rd Mario Orlich | ITA |
| 4th Geoffrey McGillivray | AUS |
| 5th Peter Wolfe | IRL |

Masters

| | |
|----------------------|-----|
| 1st Keith Wilkins | GBR |
| 2nd Peter Seidenberg | CAN |
| 3rd Barry Waller | AUS |
| 4th Willi Gerlinger | GER |
| 5th Ilkka Schroderus | FIN |

Great Masters

| | |
|------------------------|-----|
| 1st Colin Lovelady | AUS |
| 2nd Friedhelm Lienfeld | GER |
| 3rd Heinz Gebauer | CAN |
| 4th Nick Paine | GBR |
| 5th Tony Denham | AUS |

1990 New Bedford, USA
Entries 112 Countries 19

Apprentices

| | |
|-----------------------------|-----|
| 1st Kim Zetterberg | USA |
| 2nd Michael Stovin-Bradford | AUS |
| 3rd Mark Phillips | AUS |
| 4th Geoffrey McGillivray | AUS |
| 5th Had Brack | USA |

Masters

| | |
|----------------------|-----|
| 1st Denis O'Sullivan | IRL |
| 2nd Peter Seidenberg | CAN |
| 3rd Joe Van Rossem | CAN |
| 4th Curt Blidner | SWE |
| 5th David Olson | USA |

Grand Masters

| | | |
|-----|---------------------|-----|
| 1st | Friedhelm Lixenfeld | GER |
| 2nd | Jim Christopher | USA |
| 3rd | Tony Denham | AUS |
| 4th | Norman Freeman | USA |
| 5th | Nick Paine | GBR |

1989 Aarhus, DEN

Entries 114 Countries 25

Apprentices

| | | |
|-----|-----------------|-----|
| 1st | Keith Wilkins | GBR |
| 2nd | Phil Graves | CAN |
| 3rd | Jeff Loosemore | AUS |
| 4th | Had Brick | USA |
| 5th | Peter Griffiths | NZL |

Masters

| | | |
|-----|------------------|-----|
| 1st | John Rigg | AUS |
| 2nd | Curt Blidner | SWE |
| 3rd | Christer Baath | SWE |
| 4th | Denis O'Sullivan | IRL |
| 5th | Peter Seidenberg | CAN |

Grand Masters

| | | |
|-----|---------------------|-----|
| 1st | Friedhelm Lixenfeld | GER |
| 2nd | Jack Swenson | USA |
| 3rd | Heinz Gebauer | CAN |
| 4th | Nick Paine | GBR |
| 5th | Robert Saltmarsh | USA |

1988 Falmouth, GBR

Entries 156 Countries 24

Apprentices

| | | |
|-----|----------------|-----|
| 1st | Jeff Loosemore | AUS |
| 2nd | Philip Graves | CAN |
| 3rd | Had Brick | USA |
| 4th | Keith Wilkins | GBR |
| 5th | Peter Heywood | AUS |

Masters

| | | |
|-----|------------------|-----|
| 1st | Peter Seidenberg | CAN |
| 2nd | Colin Lovelady | AUS |
| 3rd | John Maynard | GBR |
| 4th | John Rigg | AUS |
| 5th | Nils Andersson | USA |

Grand Masters

| | | |
|-----|---------------------|-----|
| 1st | Friedhelm Lixenfeld | GER |
| 2nd | Geoffrey Myburgh | RSA |
| 3rd | Heinz Gebauer | CAN |
| 4th | Peter Milnes | USA |
| 5th | Jan Nouwen | NED |

1987 Melbourne, AUS

Entries 106 Countries 22

Apprentices

| | | |
|-----|-----------------|-----|
| 1st | Phil Peglar | AUS |
| 2nd | Wanwick Philips | AUS |
| 3rd | John Sprague | AUS |
| 4th | Geoff Gale | AUS |
| 5th | Willi Gerlinger | GER |

Masters

| | | |
|-----|------------------|-----|
| 1st | John Rigg | AUS |
| 2nd | Michael Heath | AUS |
| 3rd | Peter Seidenberg | CAN |
| 4th | Colin Lovelady | AUS |
| 5th | Greg Marshall | AUS |

Grand Masters

| | | |
|-----|----------------|-----|
| 1st | Alan Clark | AUS |
| 2nd | Alec McClure | AUS |
| 3rd | Graham Gilbert | AUS |
| 4th | Doug Bates | NZL |
| 5th | Bob White | AUS |

1985 World Masters Games

Toronto, CAN

Entries 101

Apprentices

| | | |
|-----|------------------|-----|
| 1st | David Olsen | USA |
| 2nd | Ben Lashaway | USA |
| 3rd | Richard Gronblom | FIN |

Masters

| | | |
|-----|------------------|-----|
| 1st | Peter Seidenberg | CAN |
| 2nd | Colin Lovelady | AUS |
| 3rd | Peter Lundt | USA |

Grand Masters

| | | |
|-----|------------------|-----|
| 1st | Alec McClure | AUS |
| 2nd | Alexander Nimick | USA |
| 3rd | Alister Taig | USA |

1984 Pattaya, THA

Entries 62 Countries 22

Apprentices

| | | |
|-----|------------------|-----|
| 1st | Richard Verco | AUS |
| 2nd | Paul Millsom | AUS |
| 3rd | Kim Weber | FIN |
| 4th | Roger Williams | UAE |
| 5th | Ilkka Schroderus | FIN |

Masters

| | | |
|-----|------------------|-----|
| 1st | John Rigg | AUS |
| 2nd | Peter Seidenberg | CAN |
| 3rd | Colin Lovelady | AUS |
| 4th | Michael Heath | AUS |
| 5th | Denis O'Sullivan | IRL |

Grand Masters

| | | |
|-----|------------------|-----|
| 1st | Alec McClure | AUS |
| 2nd | Doug Bates | NZL |
| 3rd | Alan Clark | AUS |
| 4th | Robert Saltmarsh | USA |
| 5th | Alf Johnson | USA |

1983 Gulfport, USA

Entries 70

Apprentices

| | | |
|-----|-----------------|-----|
| 1st | Tucker Bragdon | USA |
| 2nd | Phillip Peglar | AUS |
| 3rd | Peter Branning | USA |
| 4th | Carolle Spooner | CAN |
| 5th | Roger Williams | QAT |

Masters

| | | |
|-----|----------------|-----|
| 1st | Norman Freeman | USA |
| 2nd | Randall Swan | USA |
| 3rd | Dick Rose | USA |
| 4th | Heinz Gebauer | CAN |
| 5th | Geoff Myburgh | RSA |

Grand Masters

| | | |
|-----|---------------|-----|
| 1st | Alan Clark | AUS |
| 2nd | Alan Levinson | USA |
| 3rd | Bob Saltmarsh | USA |
| 4th | Peter Milnes | USA |
| 5th | Alf Johnson | RSA |

1982 Sardinia, ITA

Entries 82

Apprentices

| | | |
|-----|-----------------|-----|
| 1st | Paul Millsom | AUS |
| 2nd | Jacky Nebrel | FRA |
| 3rd | Michael Wallace | IRL |
| 4th | Michael Heath | AUS |
| 5th | Tony Manning | AUS |

Masters

| | | |
|-----|---------------------|-----|
| 1st | Hans-Luther Striewe | GER |
| 2nd | Geoff Myburgh | RSA |
| 3rd | Nick Paine | GBR |
| 4th | Jack Swenson | USA |
| 5th | Hugo Kroth | GER |

Grand Masters

| | | |
|-----|------------------|-----|
| 1st | Alan Clark | AUS |
| 2nd | Alec McClure | AUS |
| 3rd | Cecil Walker | GBR |
| 4th | Bob Saltmarsh | USA |
| 5th | William ter Weld | NED |

1981 Bendor, FRA

Entries 52 Countries 11

Apprentices

| | | |
|-----|--------------------|-----|
| 1st | Jacky Nebrel | FRA |
| 2nd | Michael Teiklen | GER |
| 3rd | Michael Nerbollier | SUI |
| 4th | Werner Winter | GER |
| 5th | Wolf Peter Niesen | GER |

Masters

| | | |
|-----|--------------------|-----|
| 1st | Nick Paine | GBR |
| 2nd | Maudez de Cozannet | FRA |
| 3rd | Lucien Bouche | FRA |
| 4th | Horst Kimm | GER |
| 5th | Michael Tuson | QAT |

Grand Masters

| | | |
|-----|------------------|-----|
| 1st | Alan Clark | AUS |
| 2nd | Cecil Walker | GBR |
| 3rd | Pierro Marchetti | ITA |
| 4th | Vittorio Baldoni | ITA |
| 5th | John Nouwen | NED |

1980 Bendor, FRA

Entries 67 Countries 15

Apprentices

| | | |
|-----|---------------|-----|
| 1st | Svend Carlsen | DEN |
| 2nd | Werner Winter | GER |
| 3rd | Jacky Nebrel | FRA |

Masters

| | | |
|-----|---------------|-----|
| 1st | Nick Paine | GBR |
| 2nd | Alf Johnson | RSA |
| 3rd | Peter Fordham | GBR |

Grand Masters

| | | |
|-----|------------------|-----|
| 1st | Sam Small | USA |
| 2nd | Cecil Walker | GBR |
| 3rd | Vittorio Baldoni | ITA |





ILCA 7



ILCA 6



ILCA 4



www.ilcasailing.org

© ILCA

“ILCA” is a registered trademark of ILCA